



# Vcolor 679/689

**Controllers for retarding-proofing or proofing cabinets and rooms with customised graphic skin**



**ENGLISH**

**INSTALLER MANUAL ver. 3.0**

**CODE 144VC679E304**



**Important**

Read this document carefully before installation and before using the device and take all the prescribed precautions. Keep this document with the device for future consultation.

Only use the device in the ways described in this document. Do not use the device as a safety device.



**Disposal**

The device must be disposed of according to local regulations governing the collection of electrical and electronic equipment.

## Contents

1	INTRODUCTION.....	4	10.4	Defrost management (for retarding-proofing only) ..	43
1.1	Introduction .....	4	10.5	Heater management.....	43
1.2	Models available and main features.....	5	10.6	Generic humidifier management (only if E3 = 0).....	44
2	MEASUREMENTS AND INSTALLATION.....	9	10.7	Mistral (only if E3 = 1) or Zephyr (only if E3 = 2) humidifier management via the serial port .....	44
2.1	Format features.....	9	10.8	Dehumidification management.....	45
2.2	Control module measurements and installation.....	9	10.9	Condenser fan management (for retarding-proofing only) .....	45
2.3	User interface measurements .....	9	10.10	Cabinet light management .....	45
2.4	User interface installation .....	10	10.11	Door frame management (for retarding-proofing only) .....	45
2.5	EVC20P52N9XXX10 - EVC20P52N9XXX12 expansion module measurements and installation.....	11	10.12	On/stand-by relay configuration.....	45
2.6	Installation precautions .....	11	10.13	Water load management.....	45
3	ELECTRICAL CONNECTION.....	12	10.14	Dripping heater management .....	46
3.1	Vcolor 679/689 M electrical connection.....	12	10.15	Output testing .....	46
3.2	Vcolor 679/689 L electrical connection.....	13	10.16	Testing cycle .....	46
3.3	Precautions for electrical connection.....	14	11	CONNECTIVITY .....	47
4	RETARDING-PROOFING OR PROOFING OPERATION	15	11.1	Initial information .....	47
4.1	Initial information .....	15	11.2	EPoCA cloud platform .....	49
5	FIRST-TIME USE.....	15	12	USB PORT MANAGEMENT .....	50
5.1	Operating modes .....	15	12.1	Available functions .....	50
5.2	Operating the device.....	15	13	ALARMS.....	51
6	NAVIGATION.....	17	13.1	Active alarms .....	51
6.1	Initial information .....	17	13.2	ELSTEAM Mistral or Zephyr humidifier alarms .....	51
6.2	Home screen.....	17	13.3	List of proofing/retarding-proofing alarms .....	52
6.3	Cycle running screen.....	18	13.4	List of EVCO inverter alarms.....	55
6.4	Screen saver .....	21	13.5	List of ELSTEAM Mistral or Zephyr humidifier alarms	55
6.5	Settings screen .....	21	14	PARAMETERS.....	57
6.6	Welcome page.....	25	15	ACCESSORIES .....	70
7	OVERVIEW OF THE FUNCTIONS.....	26	15.1	4 relay expansion.....	70
7.1	Automatic cycle .....	26	15.2	Phase cutting speed regulator.....	70
7.2	Manual cycles.....	30	15.3	EVCO Inverter .....	70
8	MAIN FUNCTIONS .....	31	15.4	Mistral humidifier .....	71
8.1	Automatic cycle .....	31	15.5	Zephyr humidifier .....	71
8.2	Heating cycle .....	35	15.6	Safety transformer .....	71
8.3	Cooling cycle (for retarding-proofing only) .....	36	15.7	Non-optoisolated RS-485/USB serial interface .....	71
8.4	Pre- cooling cycle (for retarding-proofing only).....	37	15.8	USB plug for panel installation .....	71
8.5	Recipe book .....	38	15.9	Connecting cables .....	72
9	REGULATIONS.....	39	15.10	4GB USB flash drive .....	72
9.1	Pre-cooling (for retarding-proofing only).....	39	15.11	EVlinking Wi-Fi RS-485 module.....	72
9.2	Temperature regulation .....	39	15.12	IoT EV3 Web gateway.....	72
9.3	Humidity regulation .....	40	15.13	NTC temperature and humidity probe .....	73
10	LOAD MANAGEMENT .....	42	15.14	Humidity transducer 4÷20 mA.....	73
10.1	ON-OFF / variable speed compressor management (for retarding-proofing only) .....	42	16	TECHNICAL SPECIFICATIONS .....	74
10.2	Pump-down management (for retarding-proofing only).....	42	16.1	Technical data .....	74
10.3	Evaporator fan management.....	42			

# 1 INTRODUCTION

## 1.1 Introduction

Vcolor 679/689 is a controller for retarding-proofing or proofing cabinets and rooms which delivers high performance and precision regulation, thanks to a modulating output which gives control of up to ten evaporator fan speeds. The evaporator fan can also be modulated using an EVCO inverter. In the 689 models, the modulating output can also be set to control variable speed compressors. The controller's firmware can control an ultrasonic humidifier from the Mistral series or an immersed electrode humidifier from the Zephyr series via the RS-485 serial port.

By simply setting a parameter, the controller can be configured to manage retarding-proofing and proofing automatic cycles. Variables such as temperature, humidity, fan intensity and duration can be managed independently for each phase. As well as three-phase proofing cycles (re-awakening, proofing and baking delay), with blocking and holding added in the retarding-proofing cycles, there are also manual cycles such as heating for proofing and cooling/pre-cooling/heating for retarding-proofing.

The controller's innovative programmable platform gives manufacturers the freedom to personalise the graphic skin and programmes and add new languages. All they have to do is compile an ODS file and upload it using a flash drive to the USB port on the user interface. Users can store up to 100 programmes, match them to a set of preloaded images and move them to the favourites.

Users can interact remotely with their equipment and start up/stop working cycles using the EPoCA® cloud platform with Wi-Fi or Ethernet connectivity (which also enables alternative or parallel control through MODBUS TCP). For more details, compare all the connectivity options in the Technical Data table and consult the Management and Monitoring Products/Systems and the Connectivity Products/Devices sections of our website.

The controller has an open frame board and a remote user interface which consists of a 5-inch (M) or 7-inch (L) capacitive TFT touch-screen graphic display in glass which is installed horizontally either semi-recessed into the front or flush with the panel.

## 1.2 Models available and main features

The table below shows the main features of the models available.

MAIN FEATURES	KITS		OPTIONS			
	Vcolor 679 M & L with PWM output	Vcolor 689 M & L with 0-10 V output	I/O expansion module	Speed regulator	EVCO Inverters	ELSTEAM Humidifier
			EVC20P52N9 XXX12*	EVDFAN1 (only for models 679)	Compact, Slim and Slim Power	Mistral or Zephyr
<b>Power supply</b>						
Control module	115...230 VAC	115...230 VAC				
User interface	Powered by the control module	Powered by an external transformer 12VAC/20VA				
Optional modules			115...230 VAC	230 VAC	230 VAC	Mistral: 100...230 VAC Zephyr: single-phase 230/400 VAC or three-phase 460 VAC
<b>Analogue inputs</b>						
Cabinet probe (PTC/NTC)	•	•				
Evaporator probe (PTC/NTC)	•	•				
Condenser probe (PTC/NTC)	•	•				
Humidity transducer (4-20 mA)	•	•				
Temperature (NTC)/humidity EVHTP520 probe	•	•				
<b>Digital inputs (for NO/NC contact)</b>						
Door switch	•	•				
Configurable multi-purpose 1 (default high pressure alarm)	•	•				
Configurable multi-purpose 2 (default pump-down completed)	•	•				

MAIN FEATURES	KITS		OPTIONS			
	Vcolor 679 M & L with PWM output	Vcolor 689 M & L with 0-10 V output	I/O expansion module	Speed regulator	EVCO Inverters	ELSTEAM Humidifier
			EVC20P52N9 XXX12*	EVDFAN1 (only for models 679)	Compact, Slim and Slim Power	Mistral or Zephyr
Configurable multi-purpose 3 (default low pressure alarm)	•	•				
<b>Modulating output</b>						
Can be configured as 0-10 V to module the evaporator fan or as frequency for variable speed compressors		•				
Can be configured as PWM for EVDFAN1 speed regulator (evaporator fan)	•					
Configurable K1 (default compressor)	16 A	16 A				
Configurable K2 (default cabinet light)	8 A	8 A				
Configurable K3 (default humidity injection)	8 A	8 A				
Configurable K4 (default dehumidifier)	8 A	8 A				
Configurable K5 (default defrost)	8 A	8 A				
<b>Digital outputs (sealed relays, nominal resistive current @ 250 VAC)**</b>						
Configurable K6 (default heater)	16 A	16 A				

MAIN FEATURES	KITS		OPTIONS			
	Vcolor 679 M & L with PWM output	Vcolor 689 M & L with 0-10 V output	I/O expansion module	Speed regulator	EVCO Inverters	ELSTEAM Humidifier
			EVC20P52N9 XXX12*	EVDFAN1 (only for models 679)	Compact, Slim and Slim Power	Mistral or Zephyr
Configurable K7 (default humidity production)	16 A	16 A				
Configurable K8 (default pump- down)	8 A	8 A				
Configurable K9 (default door heater)	8 A	8 A				
Configurable K10 (default sanitation)			30 A			
Configurable K11 (default on/stand- by)			16 A			
Configurable K12 (alarm)			8 A			
Configurable K13 (default condenser fan)			16 A			
<b>Communications ports</b>						
RS-485 MODBUS	•	•	•		•	•
USB	•	•				
<b>Connectivity</b>						
RS-485 MODBUS RTU (built-in)	•	•	•		•	•
Wi-Fi EPoCA/MODBUS TCP (optional through the EVlinking Wi-Fi module powered by controller)	•	•				
Ethernet EPoCA/MODBUS TCP (optional through EVCO gateways EV3 Web or EVD Web)	•	•				

MAIN FEATURES	KITS		OPTIONS			
	Vcolor 679 M & L with PWM output	Vcolor 689 M & L with 0-10 V output	I/O expansion module	Speed regulator	EVCO Inverters	ELSTEAM Humidifier
			EVC20P52N9 XXX12*	EVDFAN1 (only for models 679)	Compact, Slim and Slim Power	Mistral or Zephyr
<b>Other features</b>						
Clock	•	•				
Alarm buzzer	•	•				
Management of automatic and manual cycles	•	•				
Fan intensity management		•		•	•	
Integrated humidifier management						•
Saving HACCP files	•	•				
"Programmes" function	•	•				

\* The code refers to the I/O expansion module with HC sealed relays

\*\* Consult the wiring diagram for the maximum permitted current for loads linked to the relays

For more information see section 16 "TECHNICAL SPECIFICATIONS".

The table below lists the purchasing codes of the available models:

<b>Purchasing codes</b>	<b><u>Models with PWM output</u></b>
	<p><b>Vcolor 679 M (control module + 5" user interface):</b>  <b>EVCMC679N9EH</b> (flush fit installation)  <b>EVCMC679N9EFH</b> (semi-recessed installation)</p> <p><b>Vcolor 679 L (control module + 7" user interface):</b>  <b>EVCLC679N9EH</b> (flush fit installation)  <b>EVCLC679N9EFH</b> (semi-recessed installation)</p>
	<b><u>Models with 0-10 V output</u></b>
	<p><b>Vcolor 689 M (control module + 5" user interface):</b>  <b>EVCMC679N9EH</b> (flush fit installation)  <b>EVCMC689N9EFH</b> (semi-recessed installation)</p> <p><b>Vcolor 689 L (control module + 7" user interface):</b>  <b>EVCLC689N9EH</b> (flush fit installation)  <b>EVCLC689N9EFH</b> (semi-recessed installation)</p>

For more models, contact the EVCO sales network.



## 2 MEASUREMENTS AND INSTALLATION

### 2.1 Format features

The control module is available in a split version with an open frame board. User interfaces are available in 5- or 7-inch versions for horizontal operation and have capacitive colour TFT touch-screen graphic displays.

### 2.2 Control module measurements and installation

Installation of the control module is on a flat surface with spacers.

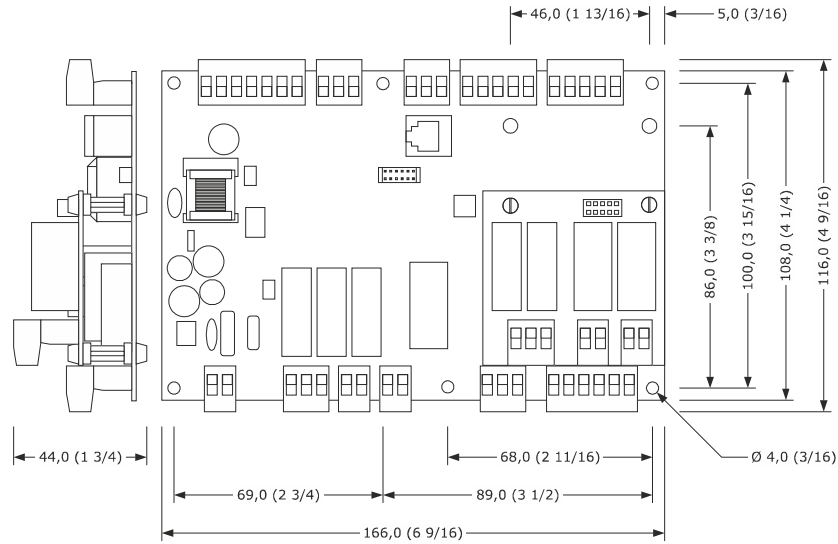

### 2.3 User interface measurements

The user interface is available in the model which is installed flush and the model which is semi-recessed into the front. The measurements vary according to the model, as illustrated below in mm (in).

#### Vcolor 679/689 M interface

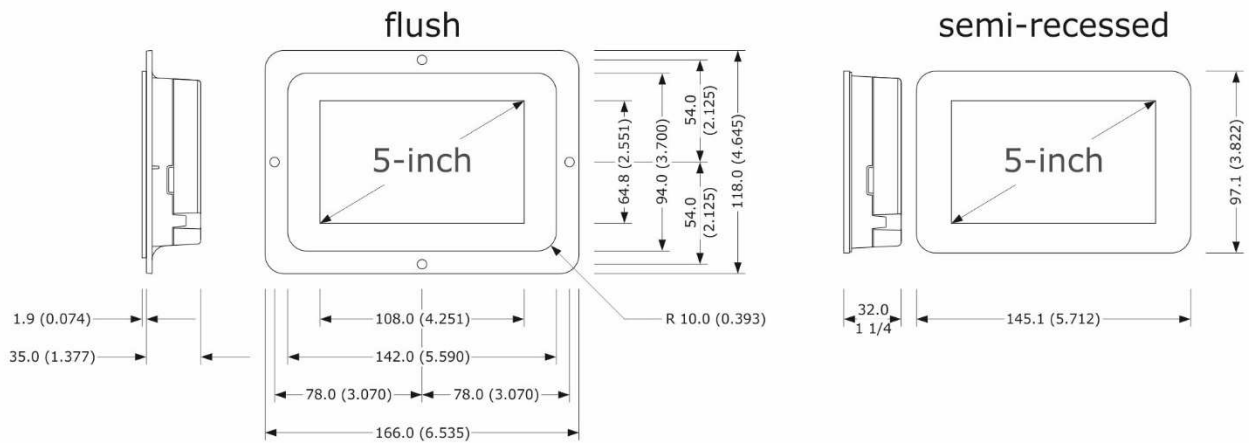

**Vcolor 679/689 L interface**

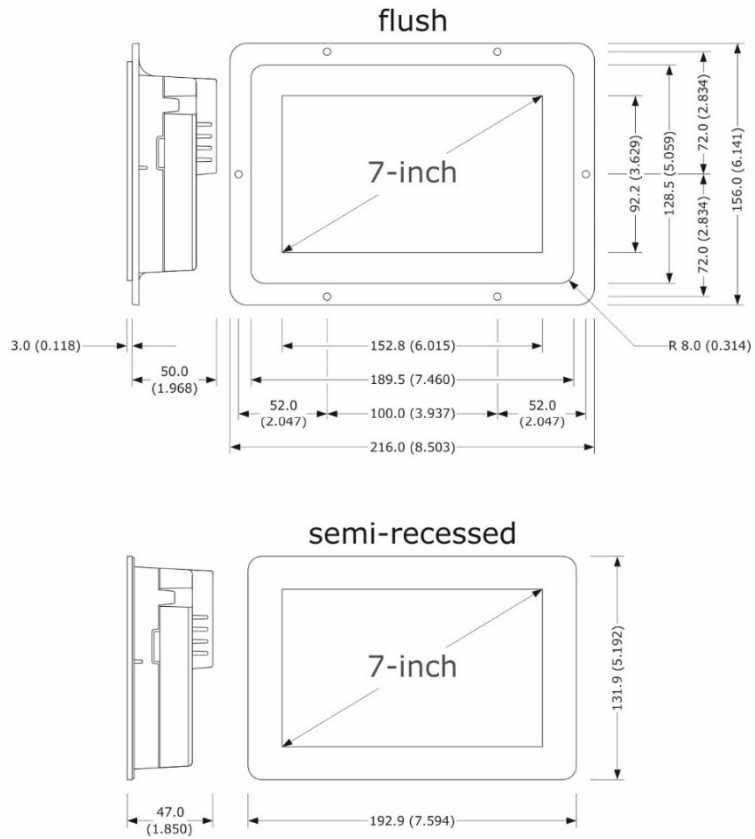

**2.4 User interface installation**

Depending on the model, installation can be:

- flush, from behind the panel with threaded studs (not provided) welded to hold it in place;
- semi-recessed, from the front of the panel with spring clips to hold it in place.

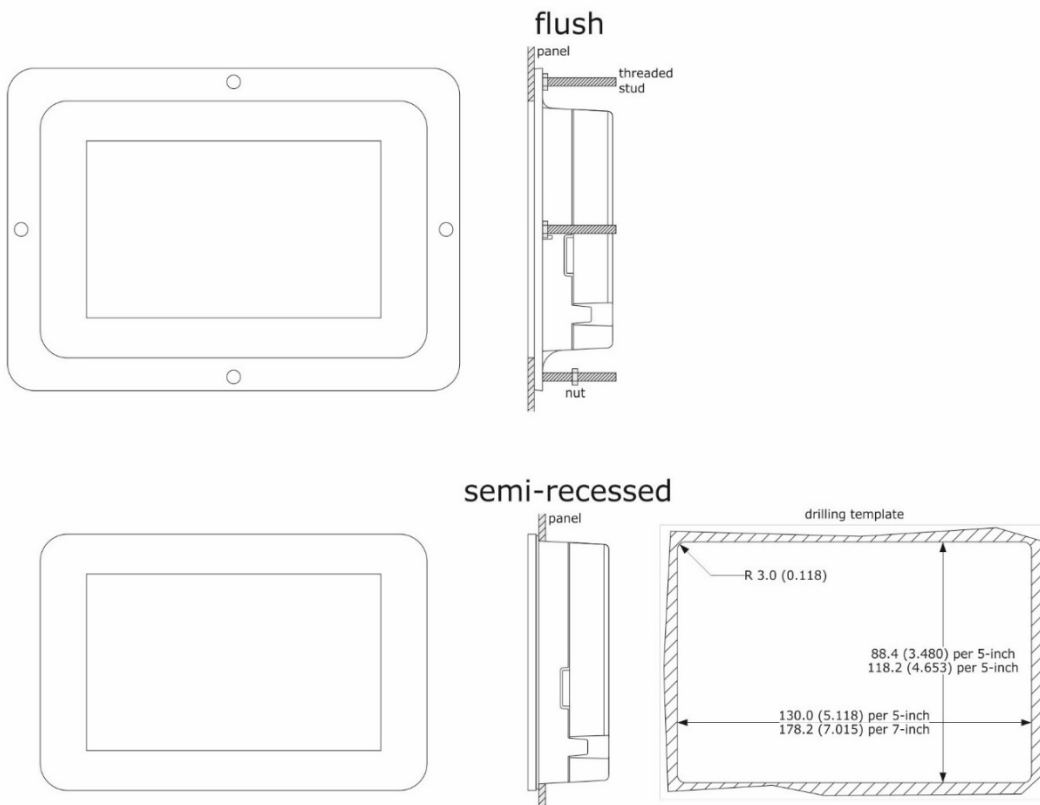

## 2.5 EVC20P52N9XXX10 – EVC20P52N9XXX12 expansion module measurements and installation

The diagram below shows the measurements of the 4 relay expansion. Installation is on a flat surface with spacers.

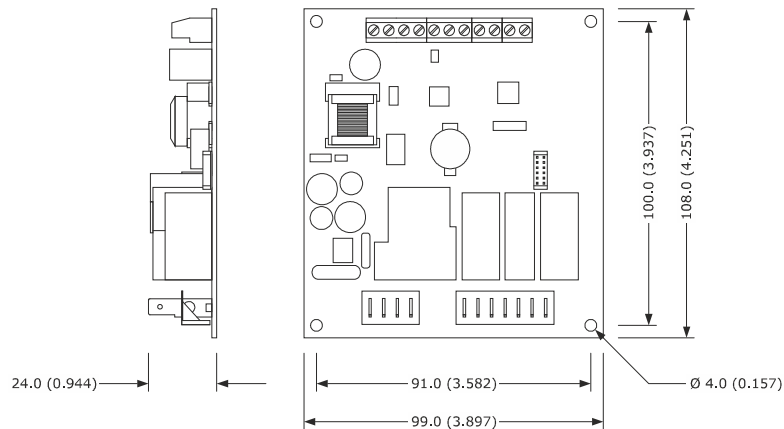

## 2.6 Installation precautions

- Ensure that the working conditions for the device (operating temperature, humidity, etc.) are within the set limits. See section 16 "TECHNICAL SPECIFICATIONS".
- Do not install the device close to heat sources (heaters, hot air ducts, etc.), equipment with a strong magnetic field (large diffusers, etc.), in places subject to direct sunlight, rain, damp, excessive dust, mechanical vibrations or shocks.
- Any metal parts close to the control module must be far enough away so as not to compromise the safety distance.
- In compliance with safety regulations, the device must be installed properly to ensure adequate protection from contact with electrical parts. All protective parts must be fixed in such a way as to need the aid of a tool to remove them.

### 3 ELECTRICAL CONNECTION

#### 3.1 Vcolor 679/689 M electrical connection

The diagram below shows the Vcolor 679/689 M electrical connection.

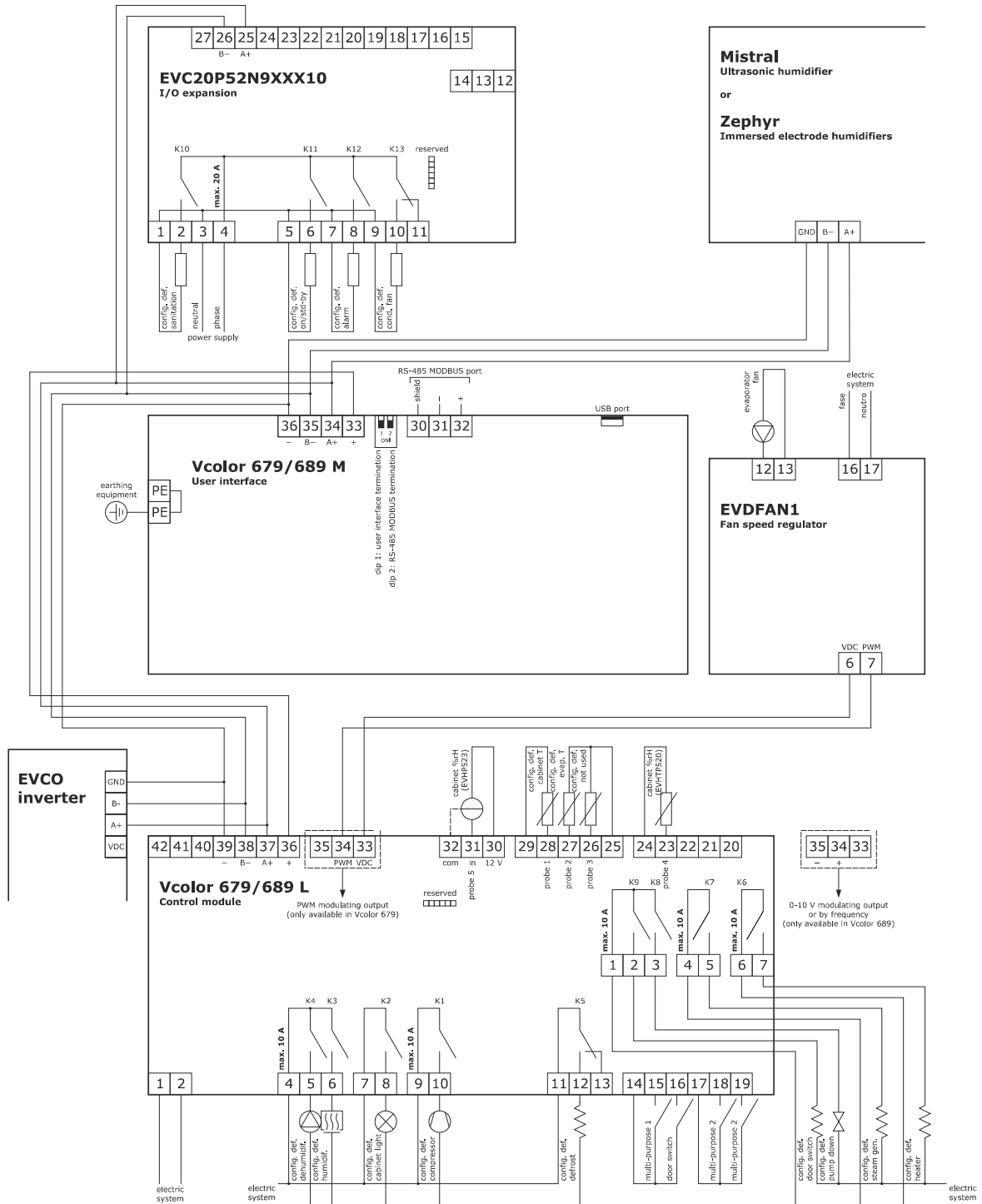

- NB:** the wiring diagram for the PWM output covers the connection to EVDFAN1 only; for other devices, please contact the EVCO sales network.
- NB:** the USB communications port makes it possible to upload and download the device settings and personalise the graphics, recipes and languages using an ordinary USB flash drive (see section "USB PORT MANAGEMENT").
- NB:** the RS-485 MODBUS communications port enables connection to the Parameters Manager set-up software or to the modules for Wi-Fi (EVlinking Wi-Fi) or Ethernet (EV3 Web/EVD Web) connectivity to manage the unit using the EPOCA cloud platform or MODBUS TCP systems (see section "CONNECTIVITY").

### 3.2 Vcolor 679/689 L electrical connection

The diagram below shows the Vcolor 679/689 L electrical connection.

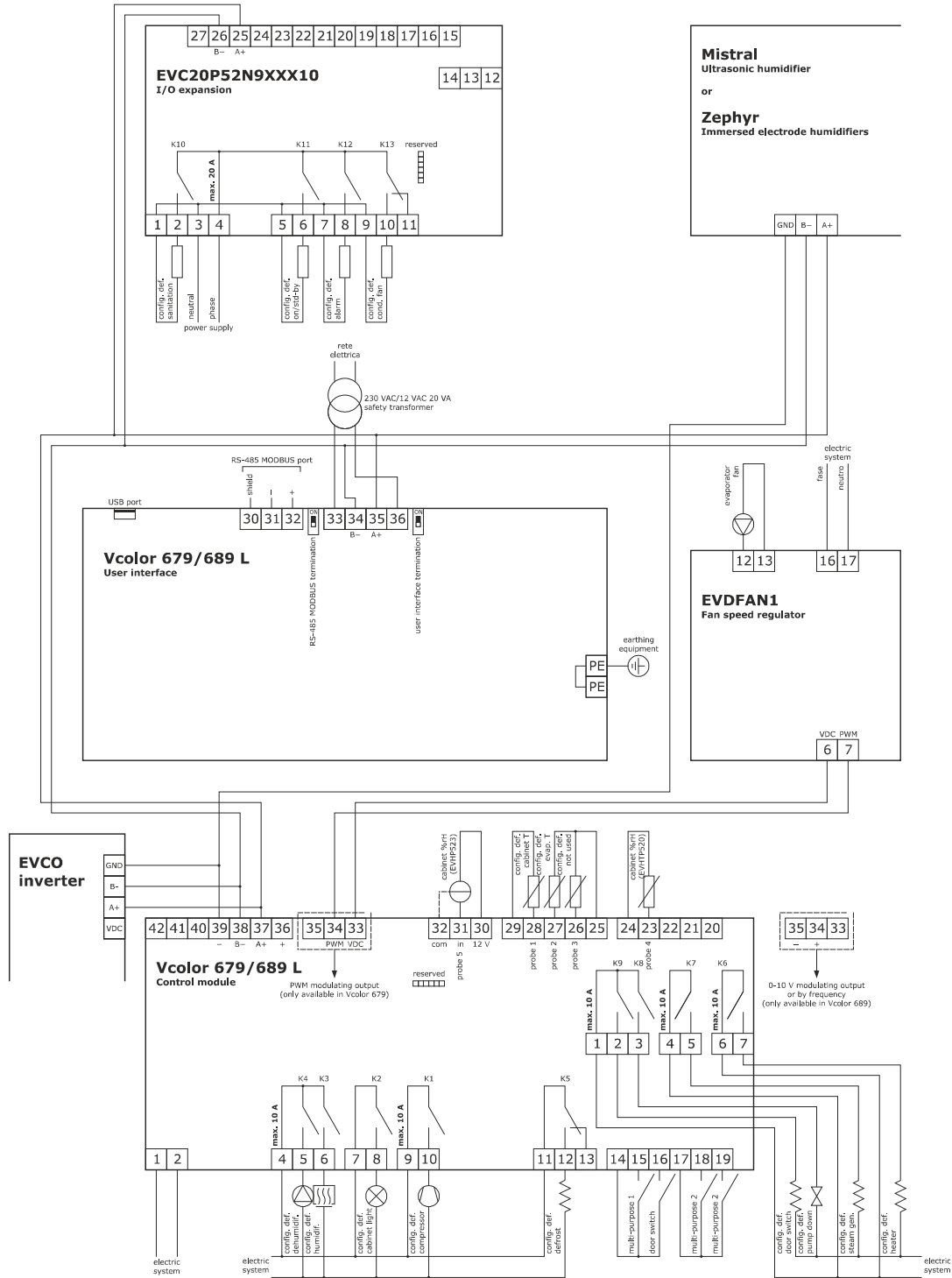

**NB:** the wiring diagram for the PWM output covers the connection to EVDFAN1 only; for other devices, please contact the EVCO sales network.

**NB:** the USB communications port makes it possible to upload and download the device settings and personalise the graphics, recipes and languages using an ordinary USB flash drive (see section "USB PORT MANAGEMENT").

**NB:** the RS-485 MODBUS communications port enables connection to the Parameters Manager set-up software or to the modules for Wi-Fi (EVlinking Wi-Fi) or Ethernet (EV3 Web/EVD Web) connectivity to manage the unit using the EPoCA cloud platform or MODBUS TCP systems (see section "CONNECTIVITY").

### 3.3 Precautions for electrical connection

- Do not use electric or pneumatic screwdrivers on the terminal blocks of the device.
- If the device is moved from a cold to a warm place, the humidity may cause condensation to form inside. Wait about an hour before switching on the power.
- Make sure that the supply voltage, electrical frequency and power of the device correspond to the local power supply. See section 1516 "TECHNICAL SPECIFICATIONS".
- Disconnect the device from the power supply before doing any type of maintenance.
- Locate the power cables as far away as possible from those for the signal.
- To reduce reflections on the signal transmitted along the cables connecting the user interface to the control module, it is necessary to fit a termination resistor.
- For repairs and for further information on the device, contact the EVCO sales network.

## 4 RETARDING-PROOFING OR PROOFING OPERATION

### 4.1 Initial information

Vcolor 679/689 is a controller which, by simply setting a parameter, can be configured to manage retarding-proofing cabinets and rooms (E12 = 1) or proofing cabinets and rooms (E12 = 0). All the cooling regulations are for retarding-proofing only; care must therefore be taken when configuring the controller for proofing (E12 = 0), that no parameters are set for cooling (see section **14. PARAMETERS**).

Automatic management of the complete dough cycle consists of three phases in the proofing configuration (re-awakening, proofing and baking delay), plus two more for retarding-proofing (blocking and holding). There are also manual cycles such as heating for proofing and cooling/pre-cooling/heating for retarding-proofing.

This manual gives instructions how to use the controller, only pointing out when there are differences between the two configurations.

## 5 FIRST-TIME USE

### 5.1 Operating modes

The controller has the following operating modes:

- "OFF" (no power to the device);
- "STAND-BY" (the device is powered but switched off);
- "ON/HOME" (the device is powered, switched on and awaiting start-up of an operating cycle);
- "RUN" (the device is powered, switched on and running an operating cycle).

Terminology: "device switch-on" means going from "stand-by" to "ON" and "device switch-off" from "ON" to "stand-by".

If there is a power failure, when power is restored the device will return to the mode set before the failure.

### 5.2 Operating the device

Follow these instructions to operate the device:

1. Install the device as shown in section 2 "MEASUREMENTS AND INSTALLATION", taking all the precautions mentioned in paragraph 2.6 "Installation precautions".
2. Make the electrical connection as shown in section 3 "ELECTRICAL CONNECTION", taking all the precautions mentioned in paragraph 3.3 "Precautions for electrical connection".
3. Connect the power supply to the device: the device will show a splash screen for 10 seconds.  
Once loading is complete, the device will display the mode it was in before being powered down:
  - stand-by screen, press the central area to move to the Home screen;
  - the Home screen.

Splash screen



Stand-by screen

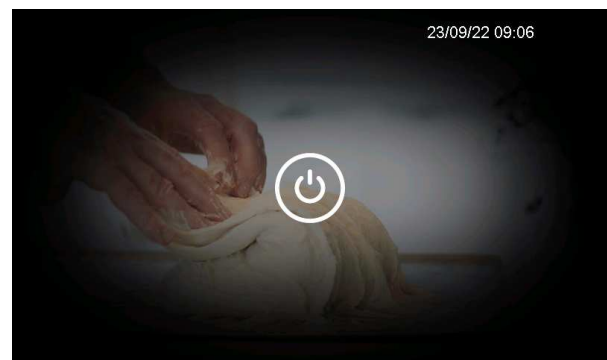



Retarding-proofing Home screen (E12=1)



Proofing Home screen (E12=0)



To switch the device on, press the central key  on the stand-by screen; to switch the device off, press the  key on the lower part of the Home screen.

**N.B.:**

If the power supply has been cut off long enough to cause a clock error (RTC alarm), it will be necessary to reset the date and time.

- From the settings key  on the stand-by screen, enter the GENERAL SETTINGS – DATE/TIME menu to set the current date and time; it is also possible to set either the EUROPEAN or US format in this screen.

EUROPEAN FORMAT

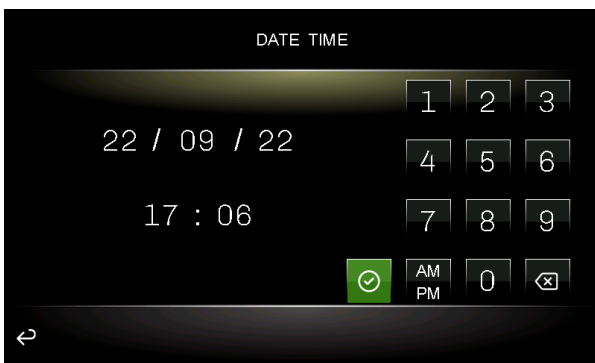

US FORMAT

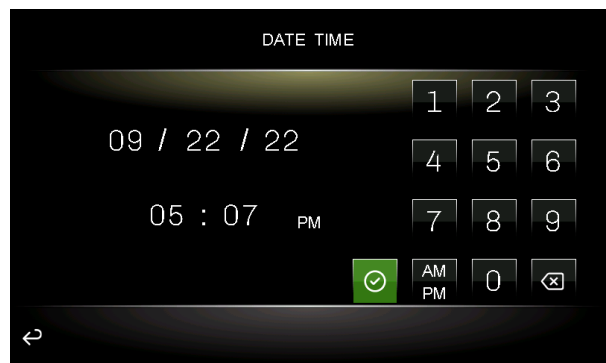

- From the settings key  on the stand-by screen, enter the GENERAL SETTINGS – LANGUAGE menu to set the language; the available languages are given below.











- From the settings key  on the stand-by screen, enter the SERVICE – PARAMETER SETTINGS menu and configure the device. The complete list of parameters is given in section 14 "PARAMETERS".



## 6 NAVIGATION

### 6.1 Initial information

Navigating the menus is intuitive, based on touch technology.

- To enter into a procedure, touch the menu or the corresponding icon.
- To exit a procedure and, in general, to return to the previous level, use the  keys.
- To scroll up and down a menu, use the  and  keys  and  to skip to the next page.
- To confirm the settings and/or changes, press the  key.
- To start up a cycle, press .
- To interrupt a cycle, press  and confirm your choice in the page displayed.
- To silence the buzzer, touch the alarm bar while it is sounding. If the buzzer sounds for the end of an automatic cycle or because the pre-cooling temperature has been reached, it will be automatically deactivated after the number of seconds set by parameter E1 (unless it is silenced manually first).





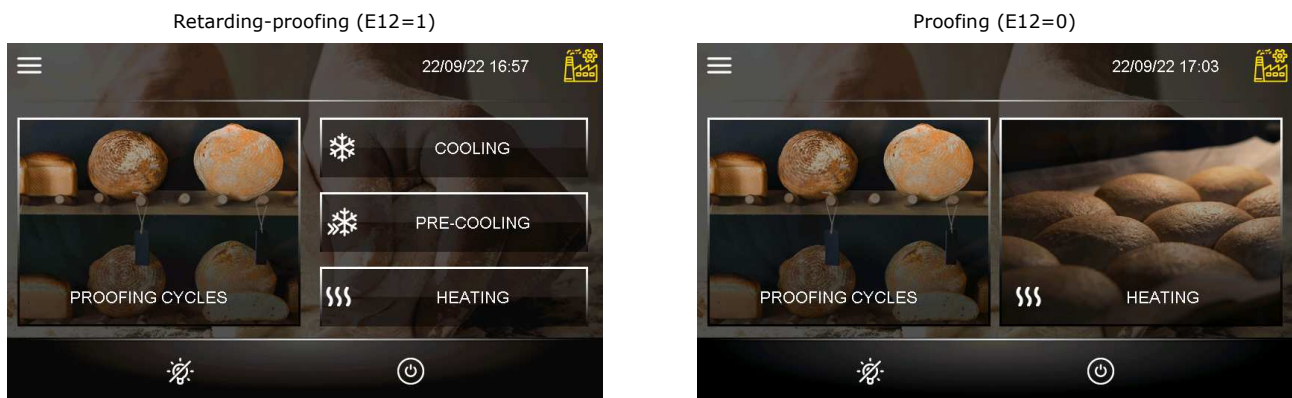

### 6.2 Home screen

The Home screen is the departure point for navigating the user interface.

The Home screen displays the functions enabled, the date and the time.



All the end user's selections start from the Home screen. The "interactive" keys grant access to the following functions:

RETARDING-PROOFING	PROOFING	FUNCTIONS
		Select and/or change and/or save automatic retarding-proofing or proofing cycles in the recipe book; start from the default recipe to select, set or start up a complete cycle
	X	Set and start up a manual cooling cycle
	X	Set and start up a manual pre-cooling cycle
		Set and start up a manual heating cycle

page.

### 6.3 Cycle running screen

Once a cycle has been started up, the Run screen will appear for the type of cycle selected.

Below are the screens for the retarding-proofing cycles (E12 = 1)

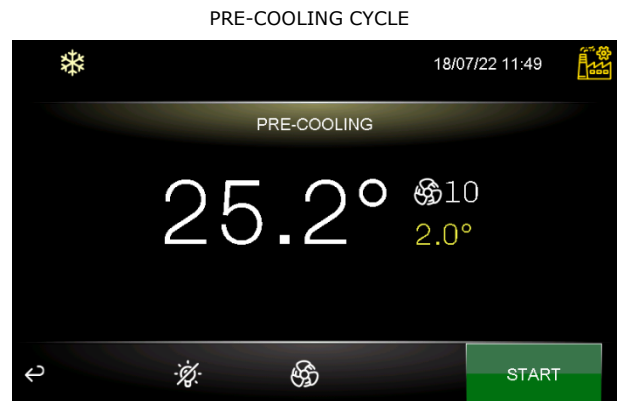
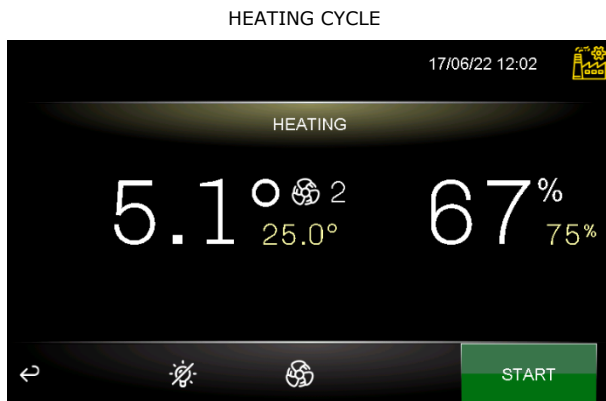
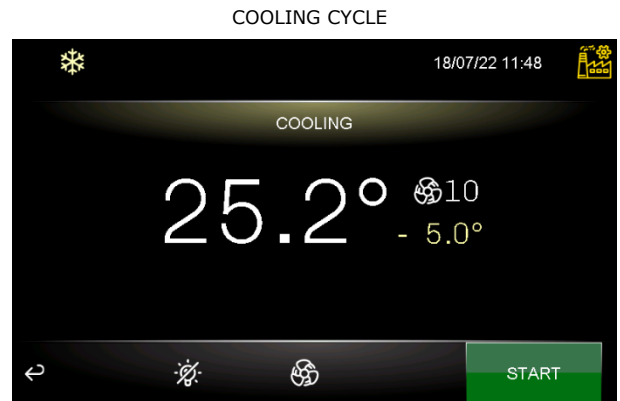

Below are the screens for the proofing cycles (E12 = 0)

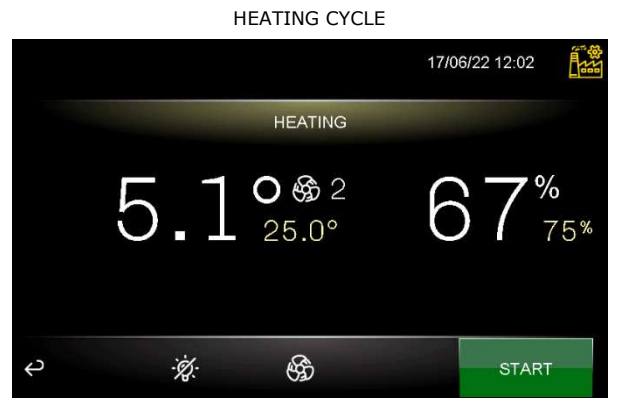

### 6.3.1 Regulator status icons

While a cycle is being run, the status of the principal loads is displayed as icons on the upper part of the screen. Below are their meanings:



On: compressor active; flashing: compressor start-up delay in progress  
N.B.: only present in the retarding-proofing configuration



On: fans working; flashing: during an ON-OFF cycle, time OFF



On: defrosting in progress; flashing: dripping time in progress  
N.B.: only present in the retarding-proofing configuration



On: heating active



On: humidification in progress



On: dehumidification in progress



On: remote connection connected; flashing: remote connection disconnected

















DOOR OPEN

On: alarm in progress

### 6.3.2 Function keys

When a cycle (both manual and automatic) is being configured or running, function keys will be displayed.

Below are their meanings:

	switch light on/off
	select fan speed (if configured for several speeds)
	enter additional functions
	exit additional functions
	start up selected cycle or recipe
	finish cycle or recipe in progress
	go from stand-by to ON and from ON to stand-by
	confirm the new set value
	confirm the selected operation
	cancel the selected operation
	delete recipe
	save new recipe
	overwrite recipe
	save recipe as favourite
	go back to Home screen
	go back to previous page

## 6.4 Screen saver

After a period of inactivity set by parameter E0, whatever screen is active at the time will switch to the screen saver showing the values detected by the probes in use. This function can be disabled by setting parameter E0=0.

To exit the screen saver, touch the display twice: the first time shows the status screen of the controller (the functions of the keys are not yet active in this screen), while the second touch reactivates all the controller's functions.

An alarm in progress also automatically shows the status screen of the controller.



## 6.5 Settings screen

The settings key  on the Stand-by and On screens gives access to the screen where sub-menus can be selected to configure the controller or check machine status and alarms; some sub-menus are not available when a cycle is in progress or the proofing cycle is set. The following screen is displayed and can be seen in full by scrolling down with the arrows on the right side of the display:

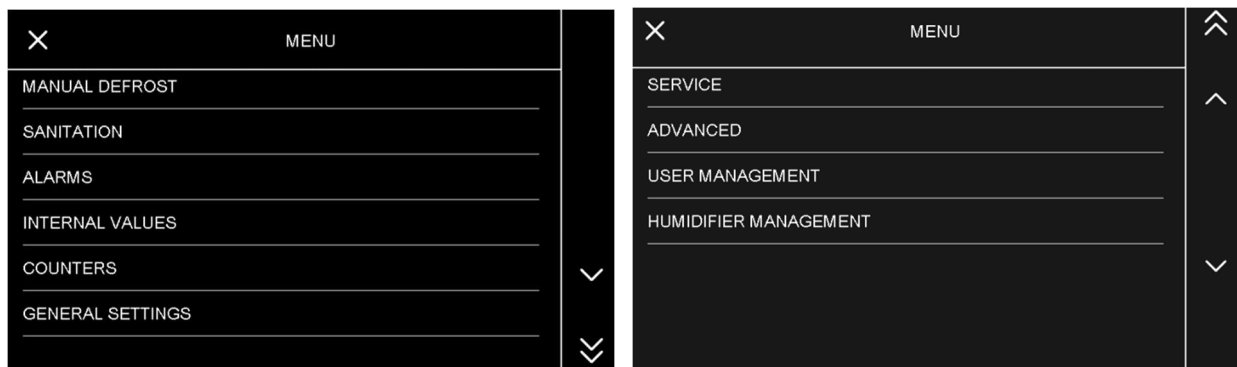

Press on a description to access the sub-menu.

### 6.5.1 Manual defrost (for retarding-proofing only)

When this option is pressed, manual defrost starts up if the conditions are met.

### 6.5.2 Sanitation

The sanitation cycle can be carried out with a UV lamp or an ionizer/ozone generator depending on parameter SA0. These cycles will only be activated when the door is closed (the label "do not open the door, sanitation cycle in progress" will appear during the cycle); if the door is opened while the cycle is in progress, the run time will be suspended. Sanitation can be activated only if the temperature of the room is higher than the temperature set by parameter SA1. The duration of the cycle is set by parameter SA2; when sanitation is carried out with an ozone generator, rest time is added at the end of the cycle which is set by parameter SA3.

The fan remains on while these cycles are running (except when the door is opened) but regulation is deactivated until the cycle has finished. The remaining time is shown as the cycle runs.

### 6.5.3 Alarms

If this option is pressed, the alarms in progress (with automatic and manual reset) are displayed.

When alarms with automatic reset are resolved, they are deleted from the list, while manual alarms must be reset by the user before they are removed from the list (if the alarm has been resolved).

#### 6.5.4 Internal values

A screen is displayed with the status or value of the controller's inputs and outputs.

#### 6.5.5 Counters (for retarding-proofing only)

Reports of machine operation times are displayed (total hours of machine operation, total hours of compressor operation, average time the compressor was switched on, average time the compressor was switched off).

Compressor operation time can be reset in this screen and compressor maintenance time is reset accordingly.

#### 6.5.6 General settings

This option gives access to the following sub-menu:

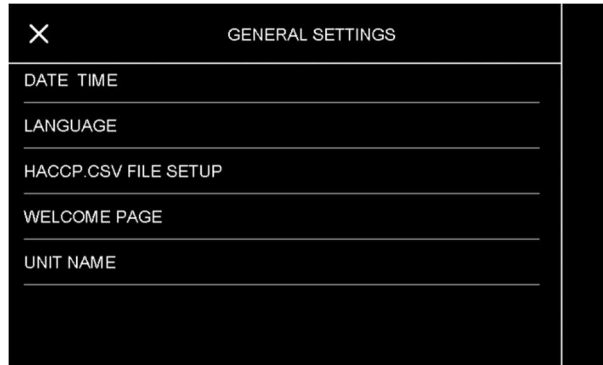

#### 6.5.7 Service

This option gives access to the sub-menu below.

PARAMETER SETTINGS is accessed with the password -19, RESTORE DEFAULT PARAMETERS with the password 149, whereas for DELETE RECIPES, FAVOURITE RECIPES, COUNTERS (for retarding-proofing only) and HISTORICAL DATA the password is 99.



### 6.5.8 Advanced

This option gives access to the following sub-menu with the password -19:



### 6.5.9 Users

The controller can manage the three user levels listed below if parameter E9=1; the user levels can only be managed when logged in as ADMIN.



USER



SERVICE



ADMIN

The default passwords to access the SERVICE or ADMIN levels are 125 and 250 respectively; these passwords can be changed by entering the user access levels menu.

Every user who is logged in as ADMIN can set or change the user password and enable/disable access to the various menu/options.



Once the user configurations have been completed, it is possible to log out manually from the Home page by pressing the icon of the user who is currently active, otherwise the controller will exit after 5 minutes.

### 6.5.10 Humidifier management (only if operation with Mistral or Zephyr is enabled)

This screen is visible only if the function is enabled for Mistral (E3 = 1) or Zephyr (E3 = 2). The list of accessible menus differs according to the humidifier enabled, as shown below.

#### Mistral

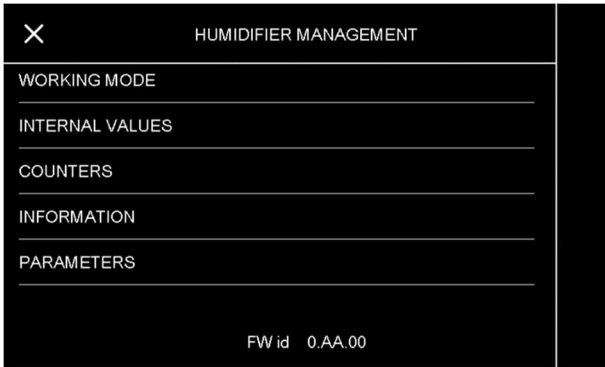

#### Zephyr

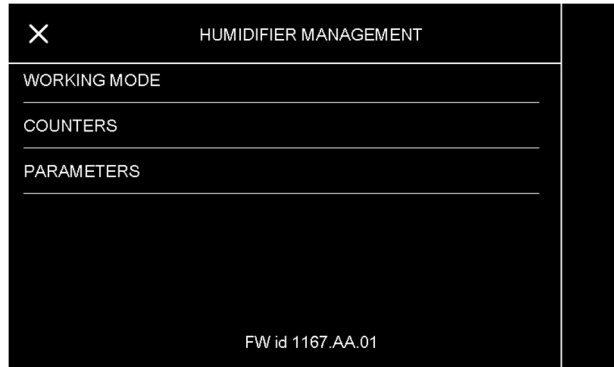

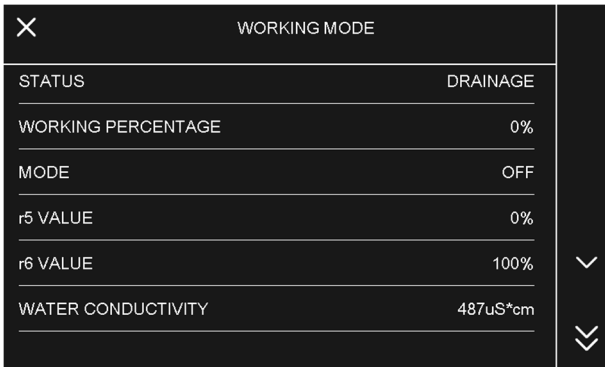

WORKING MODE: this page gives the internal working values of the humidifier and can also be viewed while a cycle is running by pressing the function key .

#### Mistral

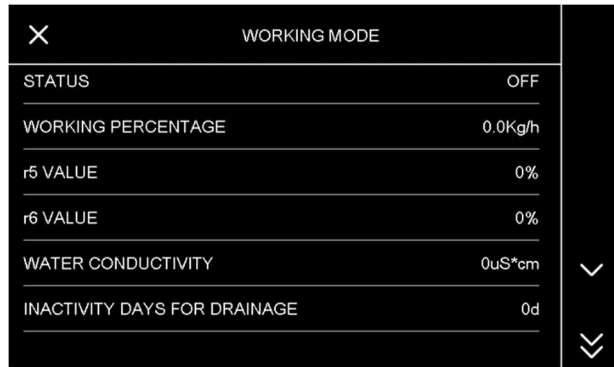

#### Zephyr



INTERNAL VALUES (for Mistral only) this page gives the status of humidifier operational variables (currents, inputs and outputs) and can also be viewed while a cycle is running by pressing the function key .

#### Mistral

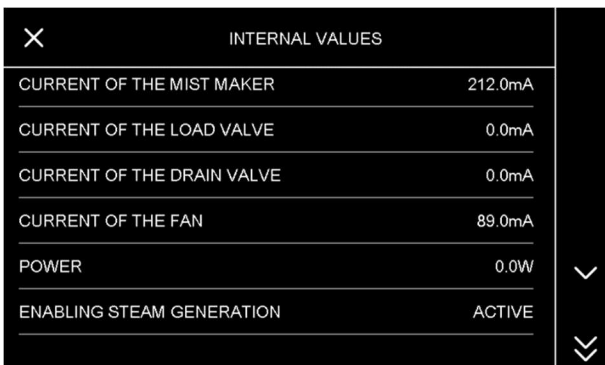



COUNTERS: the page shows a list of the operating hours counters.

**Mistral**

COUNTERS	
MIST MAKER WORKED HOURS	00h00m
FAN WORKED HOURS	00h00m

**Zephyr**

COUNTERS	
MACHINE WORKING HOURS	0h
PARTIAL WORKING HOURS BOILER	0h
TOTAL WORKING HOURS BOILER	0h
LOADING VALVE WORKING HOURS	0h
WATER DRAIN PUMP WORKING HOURS	0h
VENTILATING UNIT WORKING HOURS	0h

INFORMATION (for Mistral only): this page gives general humidifier information.

**Mistral**

INFORMATION	
Operating hours can be canceled by pressing the T1 button for a minimum of 4 seconds.	
Manual drain is activated by pressing the FNC button for at least 4 seconds. Manual drain can be required in any operating condition. During drain the LEDs turn on sequentially changing the status every second.	
FW id 1062.AA.06	

PARAMETERS: the page shows a list of the humidifier parameters available to the user.

**Mistral**

PARAMETER MANAGEMENT	
HS1	0 %
HS2	95 %
HS3	20 sec
HS4	2
HS5	500uS*cm
HS6	12 h

**Zephyr**

PARAMETER MANAGEMENT	
KHS1	20 %
KHS2	75 %
KHS5	0uS*cm
KHS6	2 d
KHS7	14 d

**6.6 Welcome page**

The welcome page can be enabled by the manufacturer to facilitate initial machine configuration. When the user switches the device on for the first time, the page will display some settings to quickly configure the controller.

These settings are:

- NAME OF DEVICE/UNIT
- DATE AND TIME
- UNIT OF MEASUREMENT
- LANGUAGE

## 7 OVERVIEW OF THE FUNCTIONS

### 7.1 Automatic cycle

The controller can automatically manage the entire dough retarding-proofing (E12 = 1) or proofing (E12 = 0) cycle.

An automatic cycle consists of several phases with different temperatures, relative humidities, fan speeds and durations. There are 5 phases for configuring retarding-proofing (blocking, holding, re-awakening, proofing and baking delay) and 3 phases for configuring proofing (re-awakening, proofing and baking delay). The phases are carried out one after the other in the following order:

Summary of retarding-proofing phases

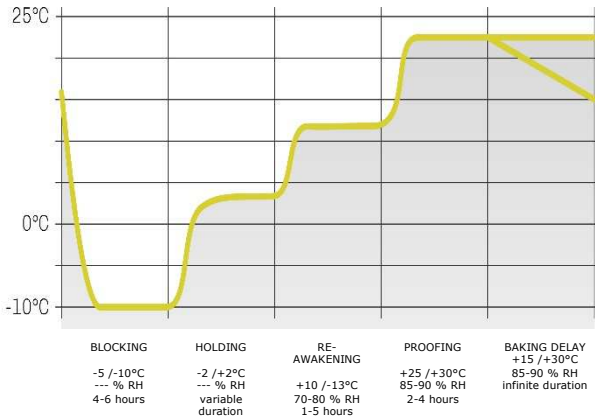

Summary of proofing phases

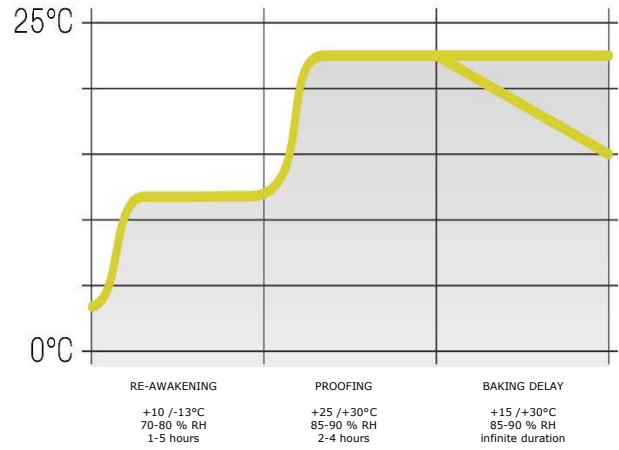

- **BLOCKING phase (phase 1 retarding-proofing)**

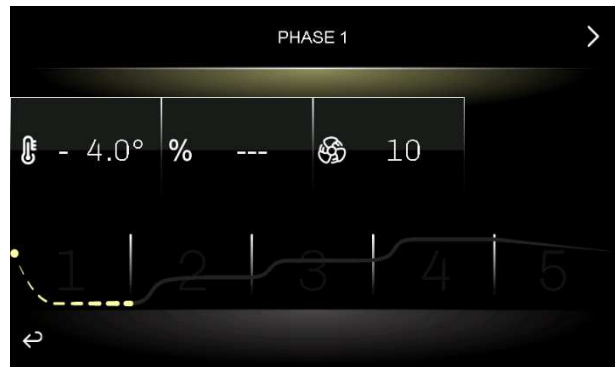
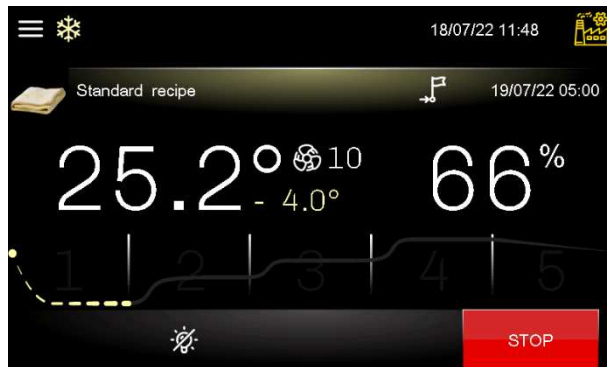

Temperature regulation is active and has a neutral zone adjustment, the temperature setpoint, humidity setpoint (if control of this is required), fan speed and duration in hours and minutes for the phase are set by the end user.

Relative humidity regulation and display are set by parameter rU4. If it is set to zero, humidity control is not carried out in this phase.

Pressing the  key halts the cycle in progress.

- HOLDING phase (phase 2 retarding-proofing)

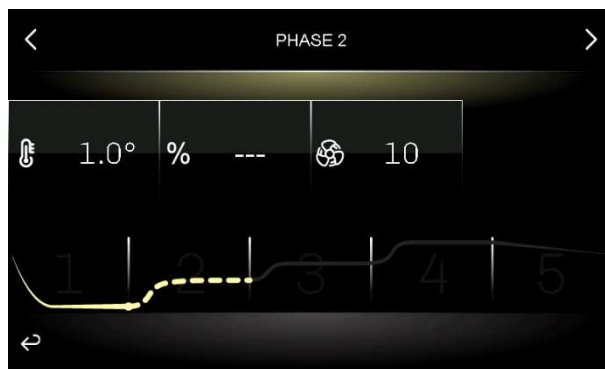

Temperature regulation is active and has a neutral zone adjustment, the temperature setpoint, humidity setpoint (if control of this is required) and fan speed are set by the end user.

Moving from the blocking setpoint (previous phase) to the holding setpoint can be gradual, with the incremental percentages set while the parameters are being set (parameters rC7 - rC10).

Relative humidity regulation is set by parameter rU4. If it is set to zero, humidity control is not carried out in this phase.

The duration of this phase is calculated automatically by the controller on the basis of the duration of the blocking, re-awakening and proofing phases and the date and time for the end of proofing required for the dough.

Pressing the **STOP** key halts the cycle in progress.

- RE-AWAKENING phase (phase 3 retarding-proofing; phase 1 proofing)

Retarding-proofing:

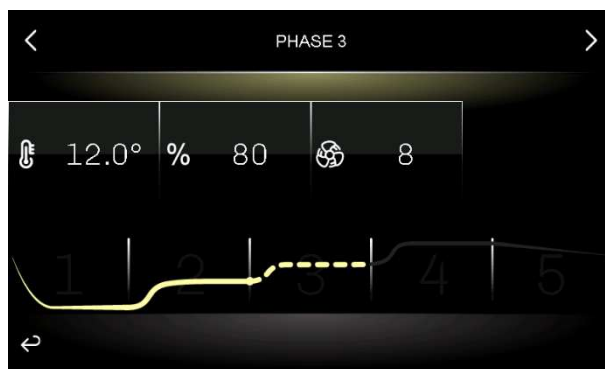

Proofing:

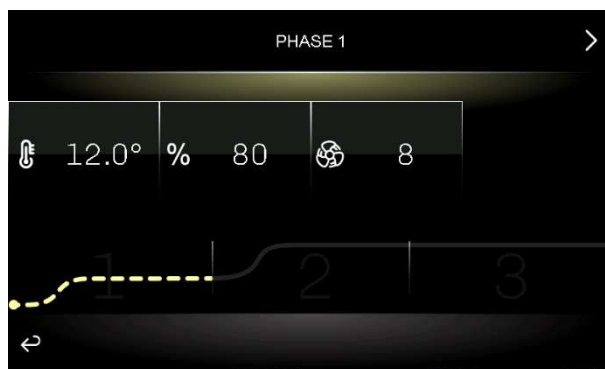

Temperature regulation is active and has a neutral zone adjustment, the working setpoint is set by the end user. The re-awakening setpoint can be reached gradually with percentage increases established when setting the parameters (parameters rr0 - rr10).

Relative humidity regulation is active and has a neutral zone adjustment, the working setpoint is set by the end user.

Duration in hours and minutes and evaporator fan speed are set by the end user.

Pressing the **STOP** key halts the cycle in progress.

- PROOFING phase (phase 4 retarding-proofing; phase 2 proofing)

Retarding-proofing:

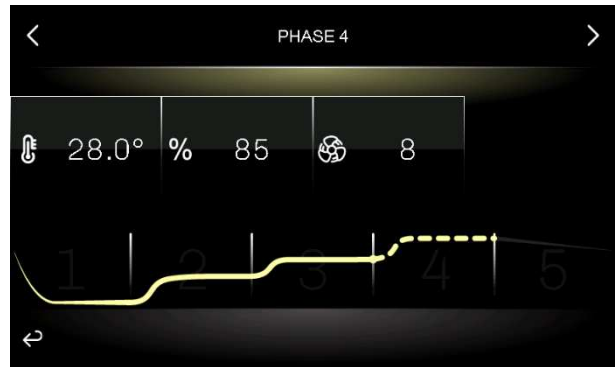

Proofing:

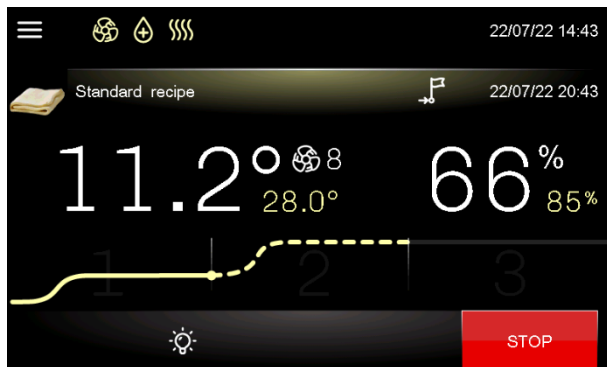

Temperature regulation is active and has a neutral zone adjustment, the working setpoint is set by the end user. Moving from the re-awakening setpoint (previous phase) to the proofing setpoint can be gradual, with the incremental percentages set while the parameters are being set (parameters rL0 - rL10).

Relative humidity regulation is active and has a neutral zone adjustment, the working setpoint is set by the end user.

Duration in hours and minutes and evaporator fan speed are set by the end user.

Pressing the  key halts the cycle in progress.

- BAKING DELAY phase (optional: phase 5 retarding-proofing; phase 3 proofing)

Retarding-proofing:



Proofing:

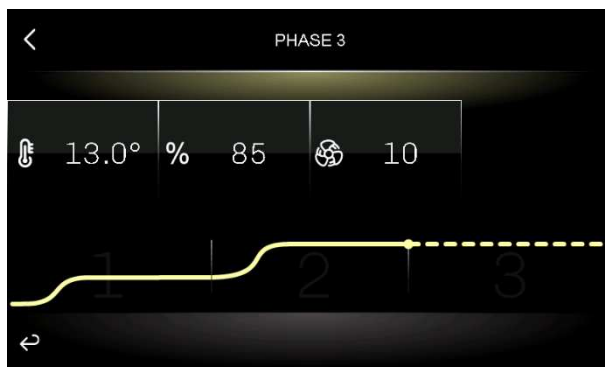

Depending on the needs of the user, the baking delay phase can be disabled (the cycle is automatically interrupted at the end of the proofing phase) or enabled with a predefined time (the cycle is automatically interrupted at the end of the counter) or an infinite duration by the end user (the cycle is automatically interrupted by pressing the  key). This may be done when setting the cycle and with the cycle in progress.

Temperature regulation is active and has a neutral zone adjustment, the working setpoint is set by the end user.

Relative humidity regulation is active and has a neutral zone adjustment, the working setpoint and evaporator fan speed are set by the end user.

At the end of the proofing phase (if the baking delay phase is not enabled) or at the end of the baking delay phase (if a finite time is set) the buzzer will sound (if parameter E1 is configured) and/or the message "CYCLE COMPLETED" will appear (if parameter E2 is configured).

When "CYCLE COMPLETED" is displayed, the page will not switch to screen saver. Touching the screen when "CYCLE COMPLETED" is displayed will open the Running Cycle screen.

- Summary of cycle phases and changing the phases

By pressing the area in the table while the cycle is running, a summary of the cycle with information about each phase is displayed.

Retarding-proofing

CYCLE INFORMATION						
	🔧	%	🌀	🕒	START	END
1	- 4.0	0	10	03:00	---	14:05 01/07
2	1.0	0	10	04:55	14:05 01/07	19:00 01/07
3	12.0	80	8	04:00	19:00 01/07	23:00 01/07
4	28.0	85	8	06:00	23:00 01/07	05:10 02/07
5	13.0	85	10	INF	---	---
←					END OF CYCLE 05:10 02/07/22	

Proofing

CYCLE INFORMATION						
	🔧	%	🌀	🕒	START	END
1	12.0	80	2	04:00	---	15:54 17/06
2	28.0	85	2	06:00	15:54 17/06	21:55 17/06
3	13.0	85	2	INF	---	---
←					END OF CYCLE 21:55 17/06/22	

While the cycle is running, it is possible to change the setpoints of the phase in progress or the following phases by pressing on the central area where the temperature and/or humidity are displayed. Phases which have already been performed will have the message "END" instead of the duration.

The duration of the phases cannot be changed while the cycle is running.

Retarding-proofing

Standard recipe						
	1	2	3	4	5	🔊
🔧	- 4.0	1.0	12.0	28.0	13.0	05:10 02/07/22
%	---	---	80	85	85	
🌀	10	10	8	8	10	
🕒	03:00	04:55	04:00	06:00	INF	
←						

Proofing

Standard Recipe						
	1	2	3	🔊		
🔧	12.0	28.0	13.0	21:55 17/06/22		
%	80	85	85			
🌀	2	2	2			
🕒	END	END	INF			
←						

## 7.2 Manual cycles

As well as the automatic cycle, the controller also has manual working cycles:

- a HEATING cycle (which can be configured with a time-controlled or infinite duration) for both retarding-proofing and proofing;
- a COOLING cycle (which can be configured with a time-controlled or infinite duration) for retarding-proofing only;
- a PRE-COOLING cycle (which prepares the machine, reaching the setpoint and maintaining it until it is deactivated by the user) for retarding-proofing only.

## 8 MAIN FUNCTIONS

### 8.1 Automatic cycle



#### 8.1.1 Selecting, changing and starting up an automatic cycle

Every automatic cycle is selected, changed and started up from the default recipe or a pre-existing recipe. Press the automatic cycle area and view the recipes:

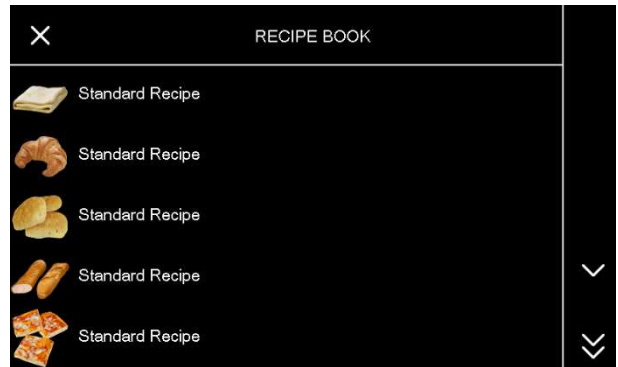
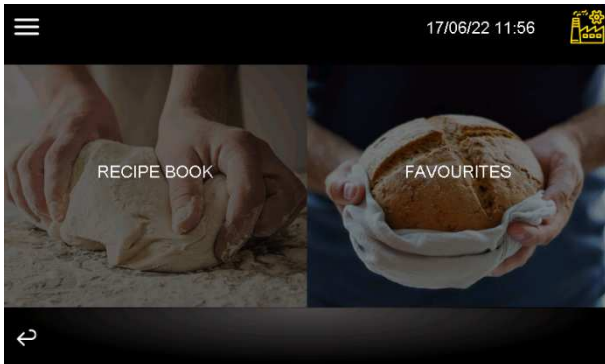

Upon selecting the desired recipe, a table with a summary of the settings for every phase is displayed.

#### Retarding-proofing

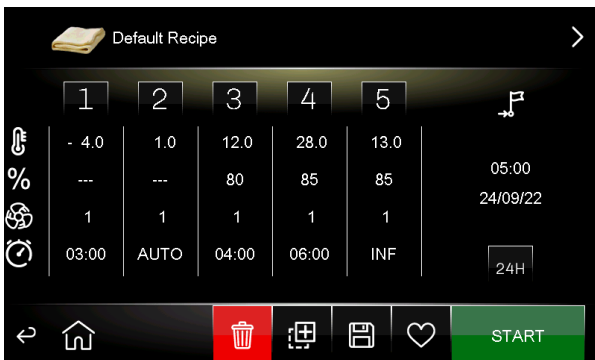

#### Proofing



The image or description of the recipe can be set or changed in this screen; touch the image on the recipe (at the top left) and a library of images loaded by the manufacturer will open:

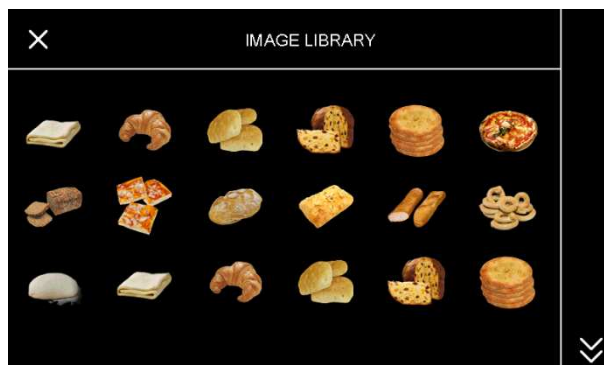

If, instead, the description of the recipe is pressed, a screen with a keyboard will open.



Pressing on the table will give access to the single screens where changes can be made to each phase (which make up a RETARDING-PROOFING cycle (blocking, holding, re-awakening, proofing and baking delay) or a PROOFING cycle (re-awakening, proofing and baking delay):

Retarding-proofing

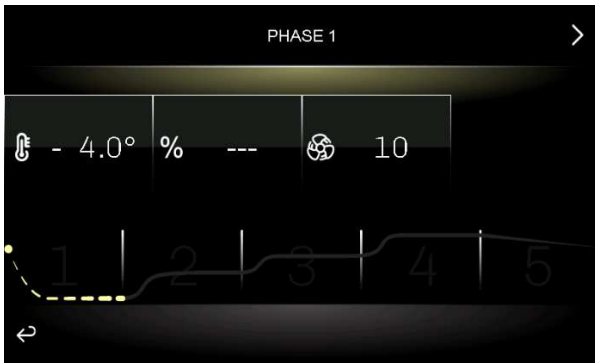

Proofing

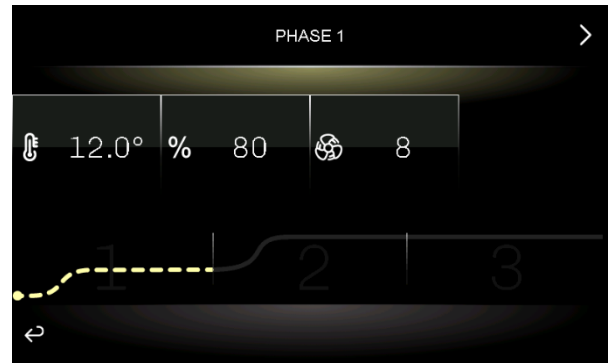

Press the arrows at the top of the display to move backwards and forwards between the phases; press the arrow at the bottom of the display to go back to the table. Select the different fields (temperature, humidity and duration) and change their values using the numerical keypad.

CHANGE END OF CYCLE TIME  
(for retarding-proofing only)

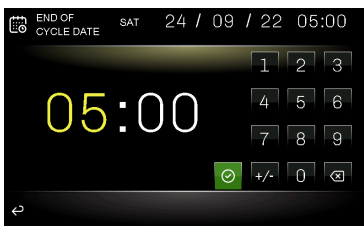

CHANGE TEMPERATURE SETPOINT

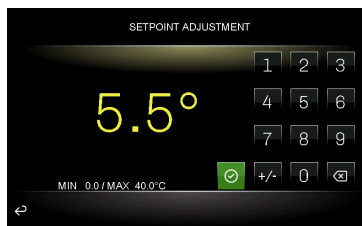

CHANGE HUMIDITY SETPOINT





Changing fan speed depends on parameter E7. If E7=0, the mode is single speed and cannot be changed. Otherwise, the following changes are possible:

- if E7=1 or 4, the speed is single or double and can be changed by pressing on the fan area
- if E7=2 or 3, there are 10 steps for the speed: to change them, press on the fan area and the following screen will be displayed

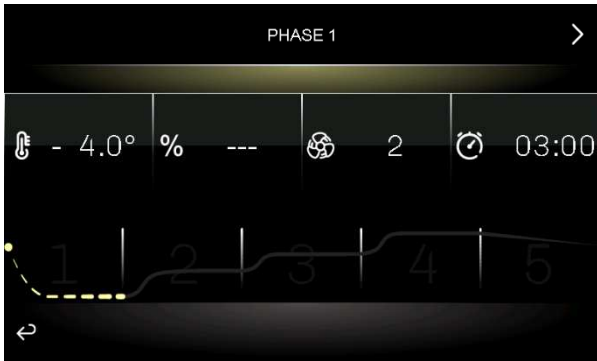

Once the cycle has been configured, go back to the table and press the key of the desired operation. Press the START key to start up the automatic cycle.

At the end of the proofing phase (if the baking delay phase is not enabled) or at the end of the baking delay phase of every cycle, the buzzer will sound (if parameter E1 is configured) and/or the message "CYCLE COMPLETED" will appear (if parameter E2 is configured).

The cycle can be interrupted manually during any phase by pressing the  key.

When managing retarding-proofing, if the end-time is later than the sum of all the timings for each phase, the controller will automatically increase the holding time (phase 2) to fill the time gap.

### 8.1.2 Time and date of cycle completion (for retarding-proofing only)

When the recipe table is shown, the time and date of the end of the cycle are shown on the right of the display. They are calculated taking into consideration the date and time when the recipe was selected and the total time set for each of the phases from 1 to 4 (except phase 2 where duration is calculated automatically and phase 5 of "baking delay").

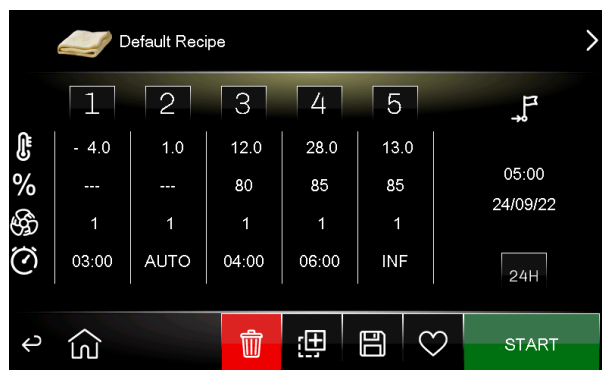





To extend the date and/or time of the end of the cycle, press the corresponding field.

**N.B: when extending the end of the cycle to the day after the set day, first press the "24H" key and then change the time.**

### 8.1.3 Automatic cycle options

The following actions can be taken from the screen with the table of the cycle/recipe:

-  start the cycle/recipe as configured in the table
-  overwrite a cycle/recipe which has previously been selected and changed
-  save a new cycle/recipe
-  view a cycle/recipe in the favourites
-  delete customised values and go back to the original recipe (the image, text and phases will be set with the default values).

The icon and/or text of the recipe can be changed before carrying out points 1, 2, 3.

Confirmation will be requested before points 2, 3 and 5 are carried out:

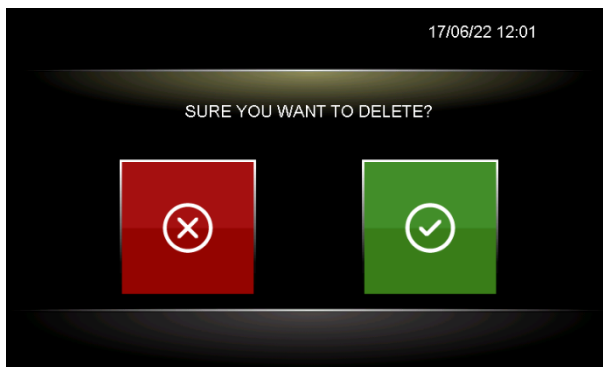

## 8.2 Heating cycle



When this cycle is selected for the first time, the following screen will be displayed, suggesting the preloaded values; if any changes are made to these values, they will be suggested the next time the cycle is selected.

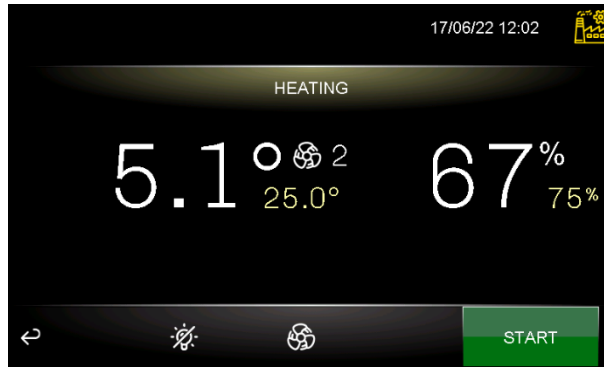

Before starting up the desired cycle, the values of the temperature setpoint, humidity setpoint and fan speed can be changed; if a timer is not set to end the cycle after the pre-determined time, the cycle will continue indefinitely.

To enable a timer, set parameter E11 to 1. The time is set by parameter MH4. Pressing the INF key (infinite time) on the bottom right of the display, the time is disabled for that cycle. Once the cycle is deselected, the value of MH4 is restored.

Selecting fan speed (e.g. with 10 speeds)



Heating setpoint

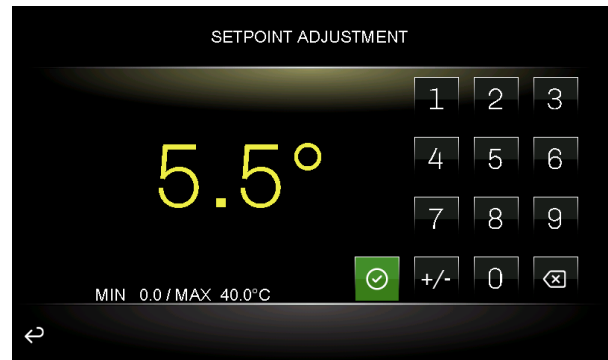

Selecting the timer

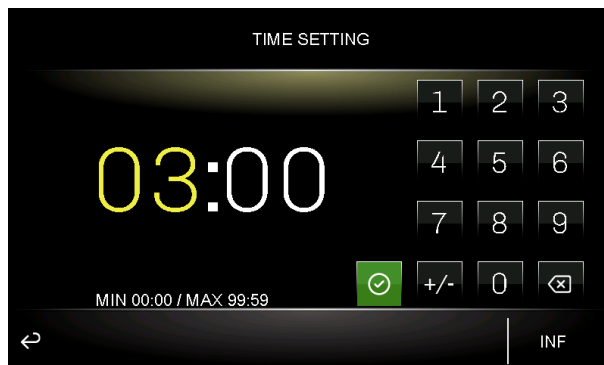

Press the  key to start up the desired cycle. Press the  key to interrupt the cycle.

### 8.3 Cooling cycle (for retarding-proofing only)



When this cycle is selected for the first time, the following screen will be displayed, suggesting the preloaded values; if any changes are made to these values, they will be suggested the next time the cycle is selected.

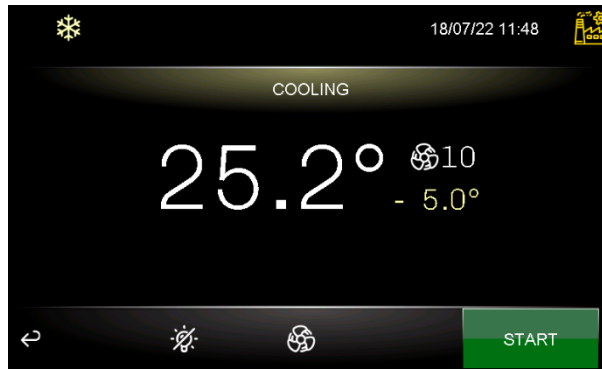

The values of the temperature setpoint and fan speed can be changed before starting up the desired cycle; if a timer is not set to end the cycle after the pre-determined time, the cycle will continue indefinitely. To enable a timer, set parameter E11 to 1. The time is set by parameter MC4. Pressing the INF key (infinite time) on the bottom right of the display, the time is disabled for that cycle. Once the cycle is deselected, the value of MC4 is restored.

Selecting fan speed (e.g. with 10 speeds)



Cooling setpoint

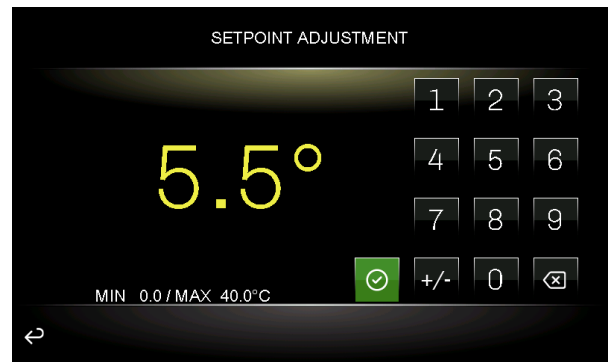

Selecting the timer



Press the  key to start up the desired cycle. Press the  key to interrupt the cycle.

### 8.4 Pre- cooling cycle (for retarding-proofing only)



A pre-cooling cycle can be activated in the chamber while waiting for the retarding-proofing cycle to be selected. Pressing the pre-cooling key opens up a screen where the cabinet temperature setpoint and the speed of the evaporator fan can be set. The function is started up by pressing the START key.

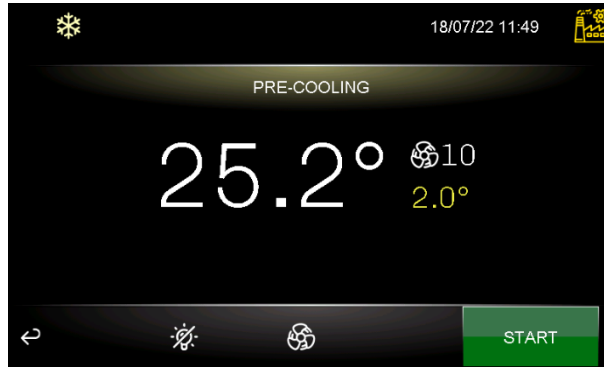

When the cycle has been activated, the controller automatically goes to the main page and displays the cabinet temperature and the setpoint to reach in the place of the pre-cooling key.



When it reaches the temperature setpoint for the first time, the buzzer will sound. If the temperature in the cabinet is equal to or lower than the setpoint, the pre-cooling function cannot be activated. The pre-cooling function is of infinite duration and ends as soon as a retarding-proofing, cooling or heating cycle is started up. To manually terminate the pre-cooling cycle, press the blue key showing the temperature.

### 8.5 Recipe book

There are two sections called RECIPE BOOK and FAVOURITES.

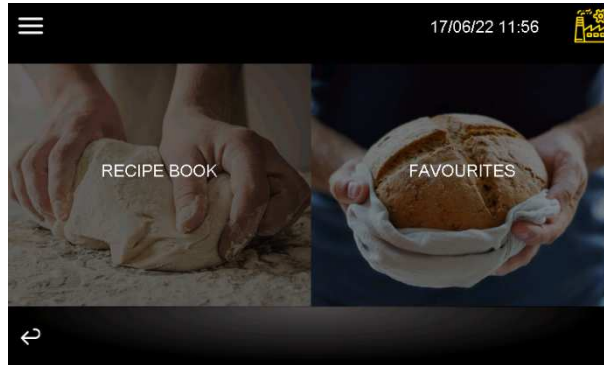

In the RECIPE BOOK section, users can save up to 99 cycles/recipes; only cycles/recipes which have previously been labelled with the  icon in the RECIPE BOOK can be stored in the FAVOURITES section.

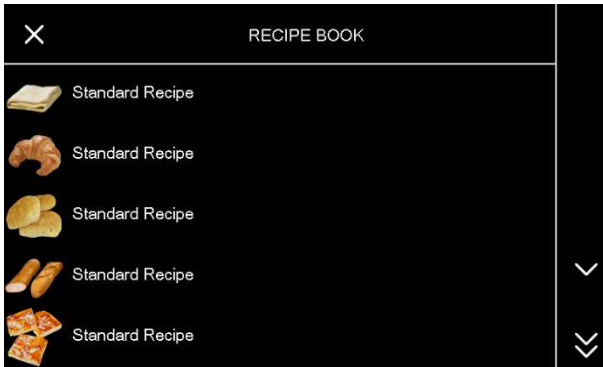

When the name of the desired recipe is pressed, the table is displayed and the cycle/recipe can be started up.

#### Retarding-proofing

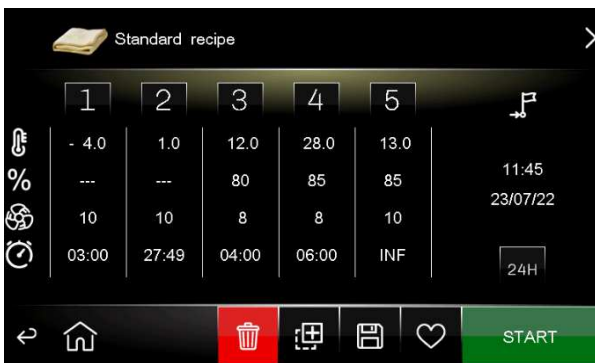

#### Proofing



## 9 REGULATIONS

### 9.1 Pre-cooling (for retarding-proofing only)

The purpose of the pre-cooling cycle is to bring the cabinet to a certain temperature (set by parameter rC6) before selecting and running a retarding-proofing cycle.

During a pre-cooling cycle, the compressor, condenser fans, pump-down solenoid valve (if enabled) and evaporator fan work to reach the set temperature.

The pre-cooling setpoint can be changed at any time during the cycle and the new value set will be reused when the next cycle is selected.

The pre-cooling cycle continues until the STOP key is pressed or until a retarding-proofing, cooling or heating cycle is started up by the user. Once the pre-cooling temperature has been reached, the buzzer sounds intermittently, indicating that the machine is ready to run the cycle. The buzzer is silenced when any key is pressed or after the time set by parameter E1.

**N.B.:** the cycle cannot be run if there is a HIGH PRESSURE, HIGH EVAPORATOR TEMPERATURE, CABINET PROBE, CONDENSER PROBE, HUMIDITY PROBE or THERMAL SWITCH alarm.

### 9.2 Temperature regulation

Temperature regulation for all phases of the equipment is in the neutral zone in which two relative values are set one above and one below the temperature setpoint, thus creating a zone inside which the loads for heating and cooling are not activated.

When the temperature rises above the neutral zone value beyond the threshold set by rC0 (cooling differential), the cooling loads are activated until the temperature returns to the neutral zone value.

Similarly, when the temperature falls below the neutral zone value beyond the threshold set by rH0 (heating differential), the heating loads are activated until the temperature returns to the neutral zone value.

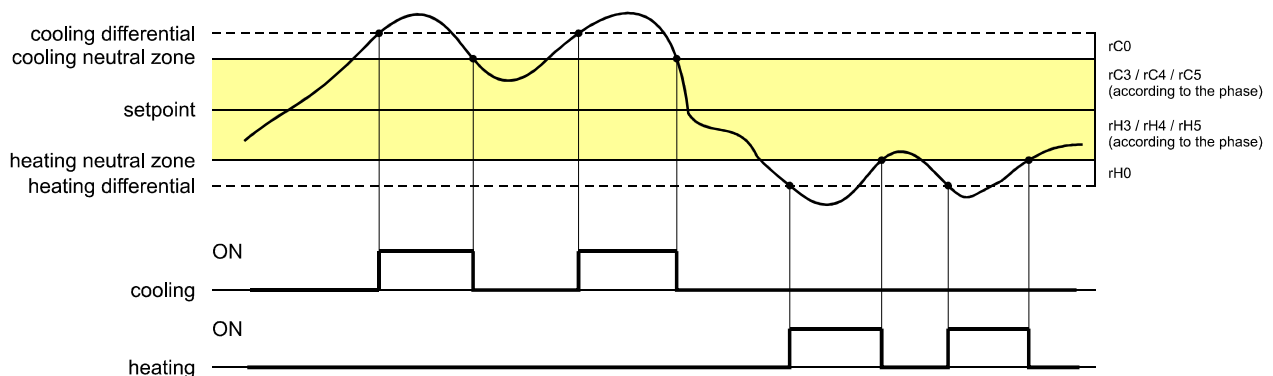

#### 9.2.1 Generating cooling (for retarding-proofing only)

Cooling is generated by the refrigeration circuit installed in the equipment.

When cooling is required, the compressor output and the pump-down solenoid valve output (if enabled) are activated.

The evaporator fan operates continuously or in parallel with the compressor, according to how the parameters have been configured for each phase and on the basis of the speed set for the phase in progress.

#### 9.2.2 Generating heat

Heat is generated by a heater.

When heating is required, the heater output is activated, with the possibility of running a duty switch on/off cycle (set by parameters rH6 and rH7), so as to limit the heating power if a very powerful heater is being used and thus avoid the cabinet overheating.

The evaporator fan operates continuously or in parallel with the heater output, on the basis of the speed set for the phase in progress.

### 9.3 Humidity regulation

In all phases where this is required, the humidity is regulated with an EVHTP520 probe or a humidity transducer 4÷20 mA (Ru0=0 and P12≠0). It is enabled in the neutral zone where two values are set, one above and one below the humidity setpoint, thus creating a zone inside which the loads for humidification and dehumidification are not activated.

When the humidity rises above the neutral zone value beyond the threshold set by rU5 (dehumidification differential), the dehumidifying loads are activated and they remain active until the humidity returns to the neutral zone value.

Similarly, when the humidity falls below the neutral zone value beyond the threshold set by rU8 (humidification differential), the humidifying loads are activated proportionally and they remain active until the humidity returns to the neutral zone value.

**NB.:** to manage humidity without a probe or transducer, see paragraph 9.7.1.

#### 9.3.1 Humidification management

Humidification is managed by two different loads: a humidity production (generator) output and a humidity injection (humidification) output

If parameters E5=0 and E6=0, the humidity production output is always active. The humidity injection output, on the other hand, is only activated when the humidity value inside the cabinet falls below the neutral zone value (set by parameter rU9) beyond the threshold set by parameter rU8 (humidification differential). The humidity injection output activation time percentage is proportional to the humidity value compared to the proportional humidification band value set by parameter rU10. The activation/deactivation cycle time of the humidity injection output is set by parameter rU11, while the duration of activation is calculated on the basis of the time set by rU12.

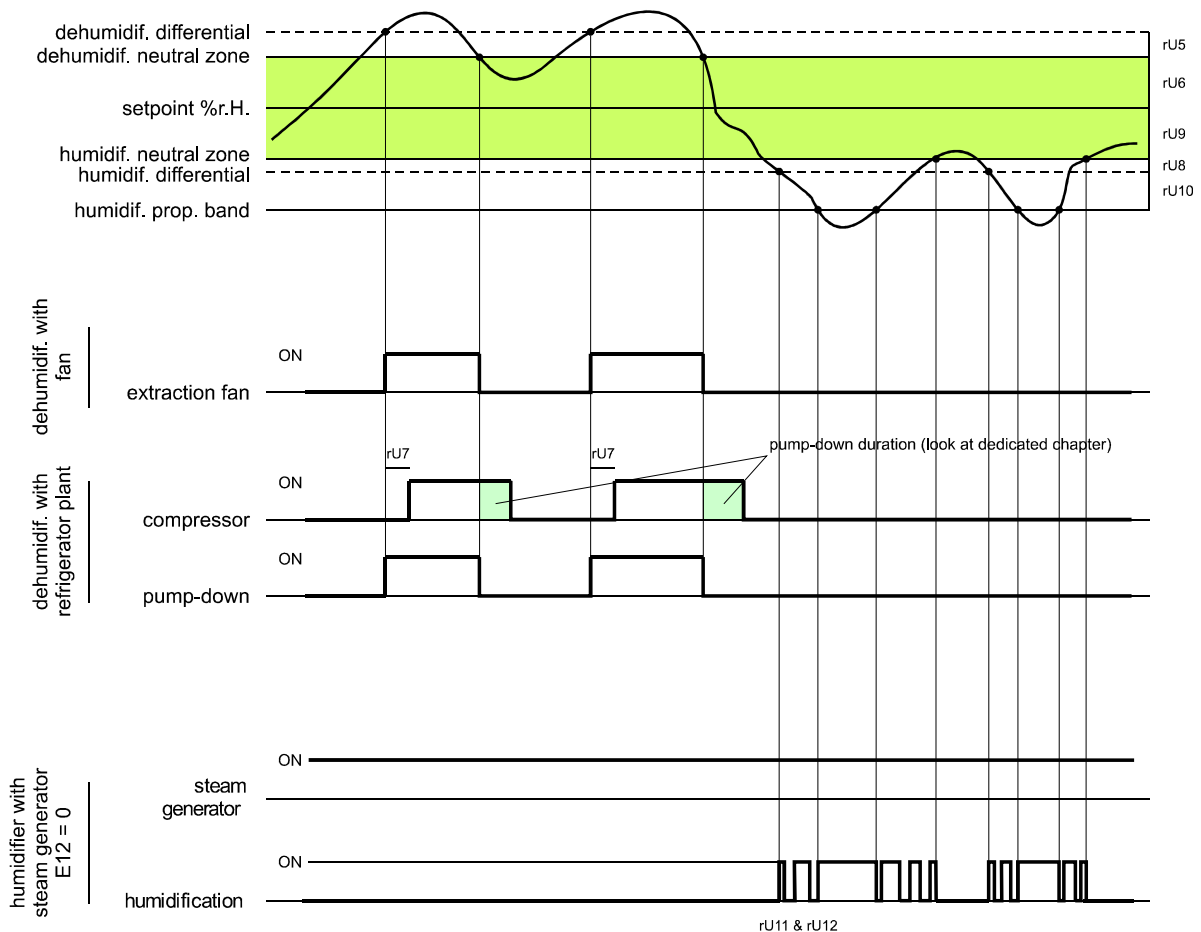

If parameters E5=0 and E6=1, the humidity injection output is activated in on/off cycles when required, always starting at the off time to allow the humidity generator to be ready to produce humidity. If parameter E5≠0 and if the phase requires the use of humidity, the humidity generator is switched on in advance with a time which is defined by parameter E5.



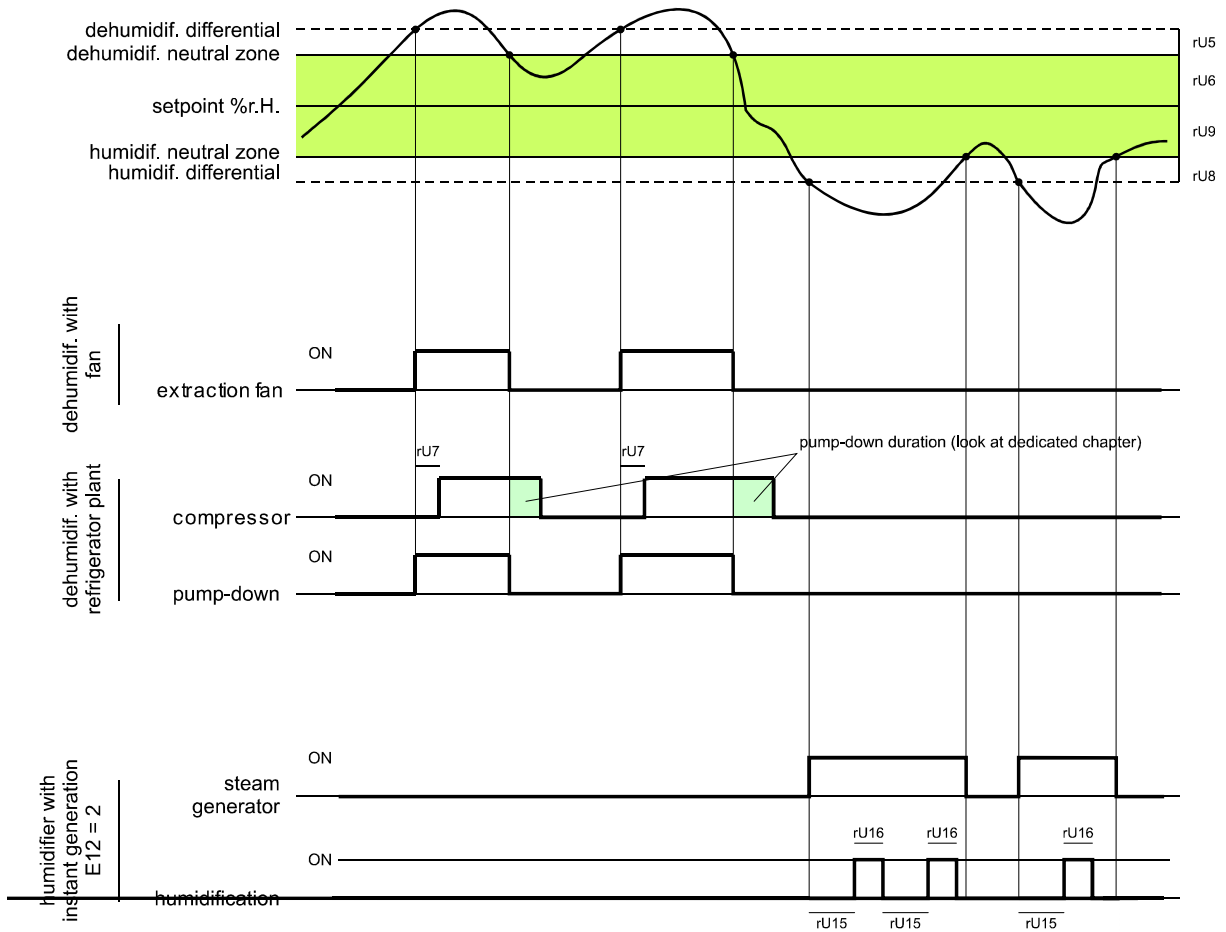

**9.3.2 Dehumidification management**

Dehumidification is managed by an extractor fan/dehumidifier (u3=0) when configured for proofing, whereas in the configuration for retarding-proofing, it can also be controlled by activating the refrigeration plant (u3=1).

When managed by an extractor fan/dehumidifier, the output will be activated when the humidity rises above the dehumidification neutral zone value (parameter rU6) beyond the threshold set by parameter rU5 (dehumidification differential) and it is deactivated when the humidity returns to within the dehumidification neutral zone value.

When managed by the refrigeration plant, if the pump-down solenoid valve is enabled (parameter uxc=8), there will be a first attempt at dehumidification by activating the solenoid valve for a time equal to parameter rU7 (to make use of the high pressure generated when the compressor is switched off). After this time has elapsed, the compressor output will also be activated if dehumidification is still requested; once the humidity returns to within the dehumidification neutral zone value, the pump-down solenoid valve will be deactivated, after which the compressor will be deactivated by the pump-down algorithm.

If the solenoid valve is not enabled, the compressor output will be activated and deactivated in the same way as the fan output.

## 10 LOAD MANAGEMENT

### 10.1 ON-OFF / variable speed compressor management (for retarding-proofing only)

Activation of the compressor depends on the length of the delay between two switch-ons (parameter C1), on the minimum duration of the compressor-off time (parameter C2), on the delayed switch-on of the compressor from the device power-on (parameter C0) and on the minimum duration of the compressor-on time (parameter C3).

The compressor can also be active during a hot gas defrost (parameter d1 = 1). In this case, in order for the defrost to start, the compressor must be active for at least the time set by parameter d15.

The compressor can also be used for dehumidification; for more details see paragraph 9.8.

Compressor switch-off is managed differently if management of the pump-down solenoid valve is required; for more details see paragraph 9.2.

A variable speed compressor can be managed instead of the ON/OFF compressor. The models that may be used are specified by parameter VC3.

Regulation of the variable speed compressor is PI and is set by parameters VC1 and VC2; using parameter VC4, it is possible to set how long the compressor remains at a speed of 85Hz before considering PI regulation at first power-on.

If necessary, parameter C9 can be set to force compressor speed to the maximum, if the compressor is still within the proportional band after the time set by this parameter has elapsed.

If cabinet temperature is lower than "Setpoint-rC0", the compressor is immediately switched off, even if integral time still has not elapsed.

Use parameters VC5 and VC6 if it becomes necessary to limit the minimal and maximum frequency of operation; always remain within the range set by the compressor manufacturer.

**N.B.:** Managing a variable speed compressor in the Vcolor 689 models is only possible when there is a modulating frequency output.

### 10.2 Pump-down management (for retarding-proofing only)

If a relay is configured as a pump-down solenoid valve (ucx=8), the controller manages the interaction between the compressor output and the solenoid valve output as follows:

When compressor activation is requested, the pump-down valve is also activated.

When compressor deactivated is requested, first the valve is deactivated and then the compressor. The compressor is deactivated as follows and depends on the configuration of u2 and the configuration parameters of the multi-purpose digital inputs:

- if u2 is set to 0, deactivation of the compressor and the valve happen at the same time;
- if u2 is set to anything other than zero and no multi-purpose input is configured for low pressure or pump-down, when there is a deactivation request, first the valve is deactivated and after time u2, the compressor is deactivated;
- if u2 is set to anything other than zero and an input is configured for low pressure, first the valve is deactivated and then the compressor is deactivated when the input closes or time u2 elapses;
- if u2 is set to anything other than zero and an input is configured for pump-down, first the valve is deactivated and then the compressor is deactivated when the input closes or time u2 elapses; if time u2 expires, the pump-down alarm is also triggered.

### 10.3 Evaporator fan management

**N.B.:** the evaporator fan can be managed by the PWM output (Vcolor 679) or the 0-10 VDC output (Vcolor 689) depending on the model.

The evaporator fan is managed according to the configuration of parameter E7. It can be configured for each phase in the cycle to work continuously or in parallel with the regulation output, ie. in parallel with the compressor, heater, humidification and dehumidification. The way it behaves is set by parameters F0 - F4.

It is also possible to set a regulation output delay at fan deactivation using parameter F13 and a duty-cycle with a cycle time and On time set by parameters F14 and F15 during deactivation of the main load. If parameters F14 and F15 are set to zero, there will be no activation.

During cooling phases (blocking, holding and manual cooling), the fan is only activated when the evaporator temperature is below the value set by parameter F25.

If the evaporator fan is managed by analogue output PWM or 0-10 VDC, it will also be possible to set the fan speed for each phase, considering ten speeds set by parameters F27 - F36.

When the fan is switched on, the controller manages its speed (F21) and start-up time (F22). When the start-up phase ends, the fan speed will keep to the speed set for the phase in progress, compensated between parameters F23 and F24 that set the minimum and maximum fan speed respectively.

During a defrost cycle, fan operation is set by parameter F26. At the end of the defrost cycle, the evaporator fan will remain off for the drip time set by parameter d7 and the subsequent evaporator fan stop time set by parameter F12.

### 10.3.1 EVDFAN1 module management (only for the Vcolor 679 version with PWM):

To adapt the phase-cutting regulation (T.D.F.) to all types of 230 Vac single-phase motors, a manual evaporator fan calibration procedure is recommended.

1. Set F23 at 0% and F24 at 100%.
2. Carry out a manual cycle and vary the fan speed, check the minimum percentage below which the fan switches off and the maximum percentage above which the fan runs at maximum.
3. Set these values for F23 and F24 respectively.

### 10.3.2 Management by EVCO inverter

The evaporator fans are managed in modulating mode by the EVCO inverter which can be integrated via the RS-485 serial port. The connected inverter can be replaced by a different model or version at any time.

The controller can automatically detect the presence of an EVCO inverter. By setting parameter E10=2 (or E10=3 if there is also a relay expansion) and E7=2, the system starts up again on the HOME page.

The parameters relating to the inverter can be set from the page SERVICE – PARAMETERS – INVERTER CONFIGURATION.

Similarly to what happens in the phase cutting management mode (E7=3), up to 10 speeds can be selected for the evaporator fans when managed by the inverter. In this case, the 10 steps are set by parameters F27 - F36 (from speed 1 to speed 10 respectively) at the discretion of the user and the speeds are expressed as a percentage of the interval between the maximum speed of the motor in RPM (S204) and the minimum speed of the motor in RPM (S205).

Below is the formula for determining speed 1, for example:  $S205 + [(S204-S205) \cdot (\text{value of parameter F27})] / 100$

## 10.4 Defrost management (for retarding-proofing only)

Defrost is active during the automatic BLOCKING and HOLDING phases and during the MANUAL COOLING phase and it can be either automatic (time intervals) or manual. Manual defrost is activated by accessing the  menu from the On/Stand-by screen or during a cycle in progress.

Depending on the value of parameter d1, the machine will perform either electric or hot gas defrost cycles or when the compressor stops.

If the evaporator probe is enabled (parameter P3=1), the defrost will end when it reaches the end-of-defrost temperature (parameter d2) within a maximum time interval set by parameter d3. If the evaporator probe is not enabled (P3=0) or if it is out of order, defrost will end at the time set by parameter d3.

At the end of a defrost cycle, the controller will allocate a drip time (d7) during which all the regulation outputs will be switched off. When the dripping time finishes, the refrigeration plant will begin working again but activation of the evaporator fan will be further delayed by the time set by parameter F12.

If a hot gas defrost is being carried out, in order for the defrost to start, the compressor must be activated for at least the time set by parameter d15.

If type "B" defrost is enabled (parameter d00), traditional defrost is carried out alongside another defrost mode which is activated according to the cabinet setpoint (see parameter d01).

## 10.5 Heater management

When heat is required, the heater output will be activated, also making it possible to manage a switch-on and off duty cycle controlled by parameters rH6 and rH7.

### 10.5.1 Cabinet step heating management

The required setpoint in the re-awakening and proofing phases can be reached gradually, setting the number of steps for reaching the setpoint and the setpoint percentage increase for each step.

In the re-awakening phase, the number of steps is set by parameter rr0, while the setpoint percentage increases are set by parameters rr1 - rr10.

In the proofing phase, the number of steps is set by parameter rL0, while the setpoint percentage increases are set by parameters rL1 - rL10.

**N.B.:** the user is required to check the consistency of the number of steps set and the correct number of setpoint percentage increases. E.g. if rr0 equals 4, only parameters from rr1 to rr4 should be set.

**N.B.:** if the setpoint is changed while the cycle is in progress, the steps are disabled.

## 10.6 Generic humidifier management (only if E3 = 0)

To manage a generic isothermal or adiabatic humidifier, set E3 = 0. Below are the instructions for management of the humidity production and injection outputs.

### 10.6.1 Humidity production output management

Management of the humidity production output depends on the setting of parameters E3, E4 and E5.

More precisely:

#### E4=0

- Output always active when a cycle is running.

#### E4=1

- In phases which require humidity control, the output is active if the cabinet temperature is lower than the setpoint of the phase in progress and is deactivated if the cabinet temperature is higher.

In phases where there is no humidity control, the output is deactivated.

#### E4=2

- The output is active if the phase requires humidity control, it is deactivated if there is no control.

#### E4=3

- In phases which require humidity control, the output is active if the humidity in the cabinet is lower than the setpoint - hysteresis for the phase in progress and is deactivated if humidity in the cabinet is higher.

In phases where there is no humidity control, the output is deactivated.

**N.B.:** pre-switch-on of the humidity generator can be set by parameter E5. In this case, the humidity generator will be active for the duration of the switch-on time, irrespective of the value of parameter E4.

If parameter E5 is set to any value other than zero and humidity is required in the first phase of the cycle, the generator will be active but cabinet humidification will not during this time. The relative icon will flash to indicate this waiting situation.

### 10.6.2 Humidity injection output management

Humidity injection output management is possible with or without the use of a humidity probe/transducer (parameter rU0).

If E3=1, the humidifier is managed by the Mistral humidifier (see section 10.8).

#### **Output management without a probe**

This kind of management is obtained with the following settings: rU0 = 1.

The humidity injection output will remain active for a duty cycle that varies according to the humidity setpoint for the phase in progress.

The output activation and deactivation duration is set by parameter rU2 (humidification cycle time) and the maximum humidification time needed to obtain 100% humidity within the cabinet (rU3).

The humidification switch-on/off times will be proportional on the basis of the humidity setpoint percentage according to parameter rU3, and they will be repeated for every cycle time set by rU2.

#### **Output management with a probe and with proportional regulation**

This kind of management is obtained with the following settings: rU0 = 0, E6=0.

The humidity injection output is activated when the humidity value inside the cabinet falls below the neutral zone value (rU9) beyond the threshold set by the humidification differential (rU8).

The duration of the humidity injection output activation is proportional to the humidity value compared to the proportional humidification band value set by parameter rU10.

Parameter rU11 sets the cycle time, while parameter rU12 represents the time base used to calculate the output activation duration.

#### **Output management with a probe and with on-off cycle regulation**

This kind of management is obtained with the following settings: rU0 = 0, E6=1.

The humidity injection output is activated when the humidity value inside the cabinet falls below the neutral zone value (rU9) beyond the threshold set by the humidification differential (rU8) performing off/on cycles, the duration being set by parameters rU15 and rU16.

The count always starts from the off time.

## 10.7 Mistral (only if E3 = 1) or Zephyr (only if E3 = 2) humidifier management via the serial port

This kind of management is obtained with the following settings: rU0 = 0, E6=0.

Make sure the right connections have been made to allow serial communication via the RS-485 port and check the settings of the parameters of the enabled humidifier (see section 14. Parameters).

## 10.8 Dehumidification management

Dehumidification management is only active when humidity is managed by a humidity probe/transducer ( $rU0 = 0$ ).

Dehumidification can be managed in the first mode described below when configuring proofing and in both modes when configuring retarding-proofing:

- using an extraction fan with "uxc=15" (in this case parameter "u3" will not be considered, irrespective of the assigned value);
- by activating the refrigeration plant (compressor and pump-down solenoid valve if fitted) with "u3 = 1" and "uxc ≠ 15".

Dehumidification management is deactivated with "u3 = 0" and "uxc ≠ 16".

### 10.8.1 Extractor fan/dehumidifier management

When managed by an extractor fan/dehumidifier, the output will be activated when the humidity rises above the dehumidification neutral zone value ( $rU6$ ) plus the differential value ( $rU5$ ) and it is deactivated when the humidity returns to within the dehumidification neutral zone value.

### 10.8.2 Management by refrigeration plant activation (for retarding-proofing only)

When pump-down solenoid valve management is not enabled, the output will be activated when the humidity rises above the dehumidification neutral zone value ( $rU6$ ) plus the differential value ( $rU5$ ) and it is deactivated when the humidity returns to within the dehumidification neutral zone value.

If, however, pump-down solenoid valve management is enabled, there will be a first attempt at dehumidification by activating the pump-down solenoid valve (to make use of the high pressure generated when the compressor is switched off), for a time period set by  $rU7$ . After this time has elapsed, the compressor output will be activated.

Once the humidity returns to within the dehumidification neutral zone value, the pump-down solenoid valve will be deactivated, after which the compressor will be deactivated by the pump-down algorithm.

## 10.9 Condenser fan management (for retarding-proofing only)

The condenser fan is managed by assigning a value of "3" to one of the relay outputs.

If the condenser probe is enabled (see parameters Pr1, Pr2, Pr3), the condenser fan will be activated when the condenser temperature rises above the value of parameter F16 plus the differential value ( $F16 + 2.0\text{ °C} / 4\text{ °F}$ ), based on the configuration of parameter F18.

The condenser fan will switch off when the condenser temperature falls below the value of parameter F16.

If the condenser probe is not configured, the condenser fan will be activated in parallel with the compressor, while deactivation will be delayed for the time set by parameter F17.

During CONDENSER OVERHEAT or COMPRESSOR LOCKED alarm, the condenser fan will stay on.

The fans will be switched off during defrost.

## 10.10 Cabinet light management

The cabinet light will switch on/off if the door is opened or closed, if the  key is pressed while manual and/or automatic cycles are being carried out or if the controller is in the Stand-by screen.

Switching on with the key has priority over the door switch.

If the light is off, opening and closing the door will activate and deactivate the relative output.

If the light has been switched on with the key, opening or closing the door will have no effect on the light (the light will stay on until it is switched off from the key or the controller is put in in stand-by).

### 10.11 Door frame management (for retarding-proofing only)

The door frame heater output, if configured, is activated when the cabinet temperature goes below parameter  $u5$ ; it is deactivated when the cabinet temperature is higher than  $u5+rC0$ .

### 10.12 On/stand-by relay configuration

This output does not depend on any regulation; it is activated when the controller is ON and deactivated when the controller is in STAND-BY.

### 10.13 Water load management

The water load output (if configured setting to 17 one of the parameters from  $u1c$  to  $u13c$ ) is activated when the water load level input (if configured setting to 9 one among the parameters  $i4$ ,  $i7$  and  $i10$ ) is activated. The water loading is not enabled if no cycle is in progress, if the phase in progress is a blocking, holding or manual cooling phase and if the cabinet temperature is lower than parameter

E16. The function remains active until the input is deactivated or the timeout set by parameter u7 has elapsed. In this case, the water loading alarm is set off. This alarm shall be reset from the screen ALARM LIST; see alarm sections (6.5.3 and 13).

## 10.14 Dripping heater management

The dripping heating output (if configured setting to 18 one of the parameters from u1c to u13c) is activated during a defrost and deactivated with a delay from the end of defrost given by parameter E15.

## 10.15 Output testing

The password to enter this mode is -19.

In this mode, all the outputs (digital and analogue) in the controller can be manually activated/deactivated independently of the regulation in progress. Every output can be activated/deactivated individually.

## 10.16 Testing cycle

The password to enter this mode is -19.

A completely automatic testing cycle can be performed in this mode.

If proofing is configured, the testing cycle only applies to the heating phase (see point 1 below).

If retarding-proofing is configured, this function consists of the following phases:

- heating phase
- cooling phase
- defrost

Press the START key to start up the testing cycle:

### 1. Heating adjustment phase

The heating phase begins by checking the temperature and humidity. When setpoint T1 is reached, the heater switch-on cycles are run to complete the phase. 'Cycles' are the time of the ON phase plus the OFF phase. If the setpoint is not reached in the time set by parameter T3, the controller exits the testing cycle and the error "MAX TIME" is displayed.

If everything works correctly, the cooling phase starts up. First the T5 pull-down setpoint is reached and then compressor ON and OFF cycles are performed on the cooling phase setpoint.

### 2. Cooling adjustment phase

During this phase, probe connection is checked; the temperature of the evaporator probe must be lower than that of the cabinet, while the temperature of the condenser must always be higher than that of the cabinet. If these conditions are not met, the test ends.

This phase must not take longer than the maximum time set by parameter T7; if it does, the label "MAX TIME" will be displayed and the test ends.

### 3. Defrost phase

At the end of the temperature adjustment phase, a defrost cycle is forced (considering the standard defrost parameters, so d00=0).

A label is displayed to indicate if this phase has been terminated due to temperature or time.

### 4. Recovery phase

At the end of defrost, the controller must reach the cabinet setpoint set by parameter T9.

While the cycle is running, the temperatures of the cabinet-evaporator-condenser probes are displayed on the screen (if configured), as well as the values of the humidity probe and, for each completed phase, the time and duration of the cycle.

The test can be terminated manually at any time by pressing the STOP key.

If there is a power failure during the cycle, the cycle is interrupted when power is restored.

# 11 CONNECTIVITY

## 11.1 Initial information

Users can interact remotely with their equipment and start up/stop working cycles using the EPoCA cloud platform with Wi-Fi or Ethernet connectivity (which also enable alternative or parallel control through MODBUS TCP). For more details, compare the connectivity options in the "Models available and technical features" table and consult the Management and Monitoring Products/Systems and the Connectivity/Devices sections of our website [www.evco.it](http://www.evco.it).

Schematic diagram for operation with EVlinking Wi-Fi (Wi-Fi connectivity)

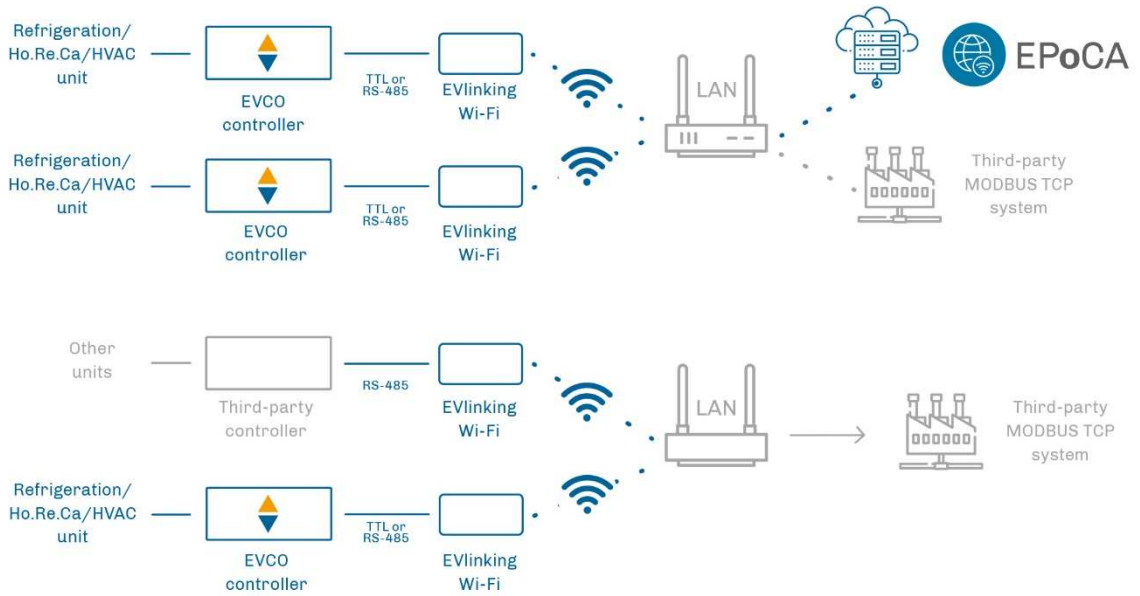

Detail of electrical connection of EVlinking Wi-Fi to Vcolor 679/689

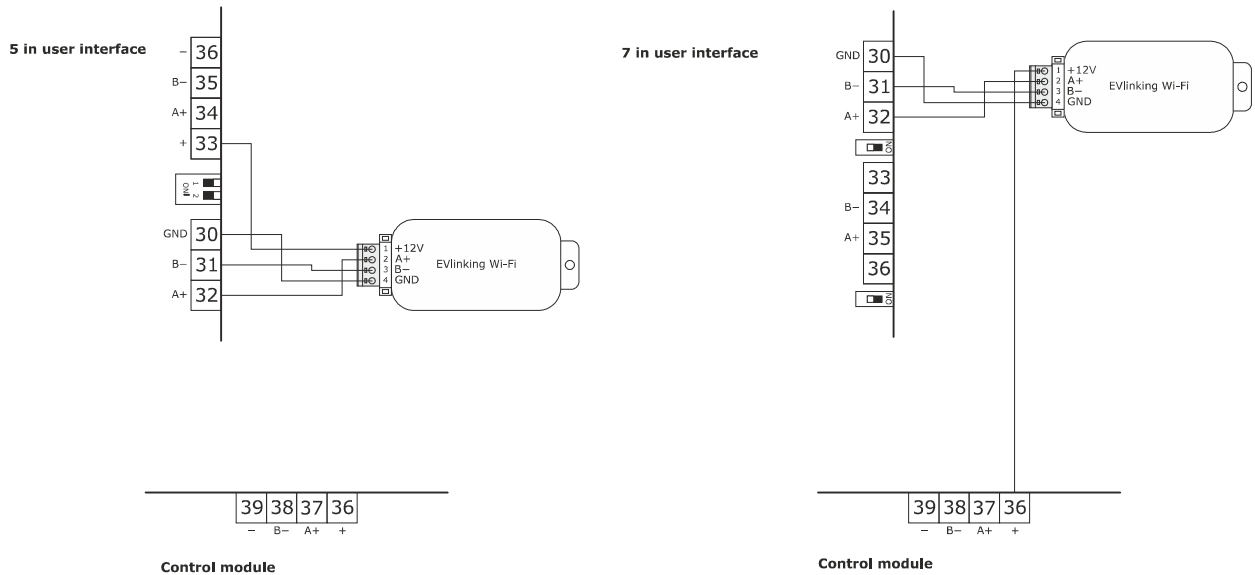

Schematic diagram for operation with EV3 Web (Ethernet connectivity)

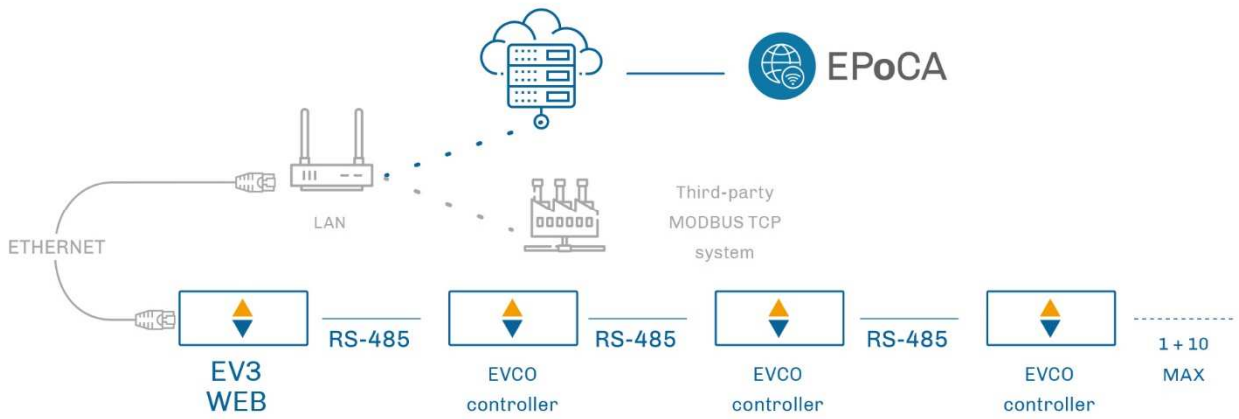

Detail of electrical connection of EV3 Web to Vcolor 679/689

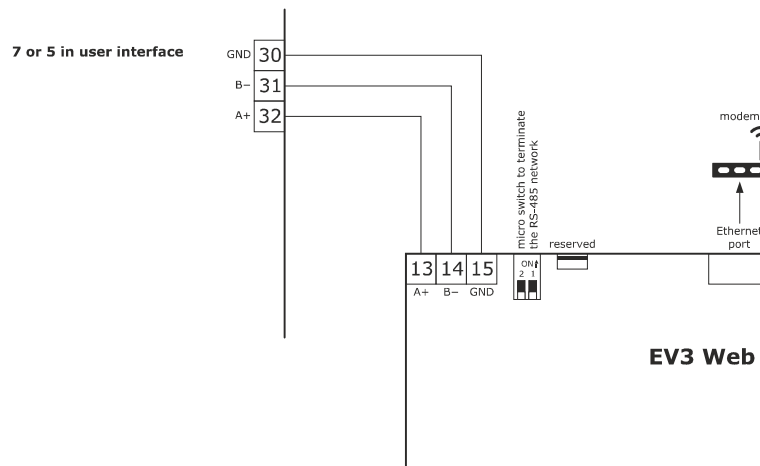



Schematic diagram for operation with EVD Web (Ethernet connectivity)

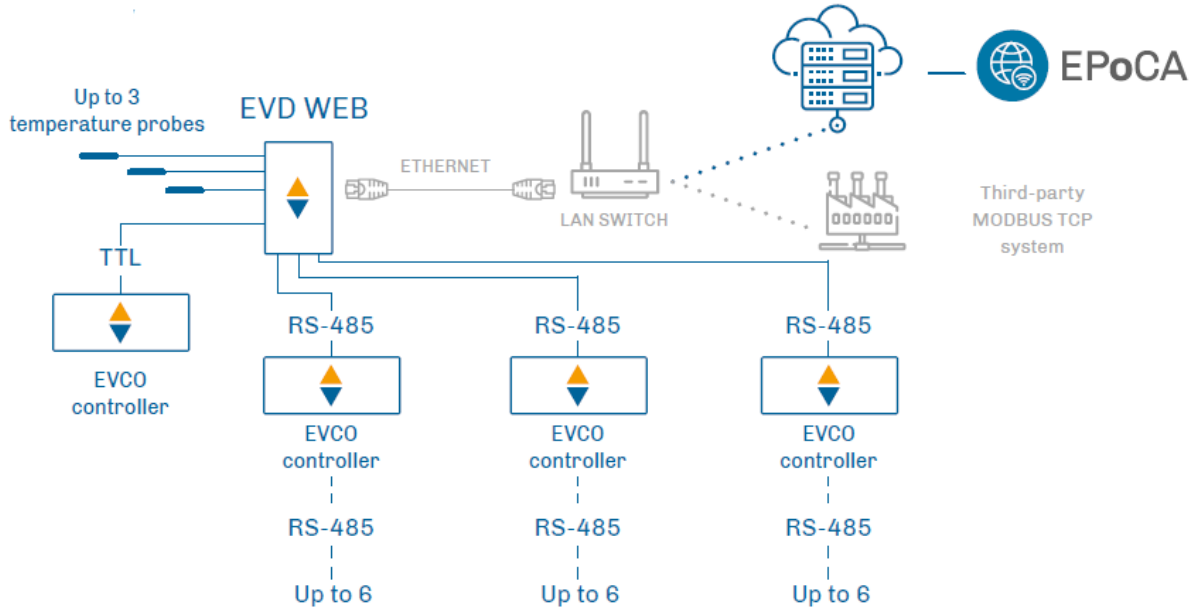

Detail of electrical connection of EVD Web to Vcolor 679/689

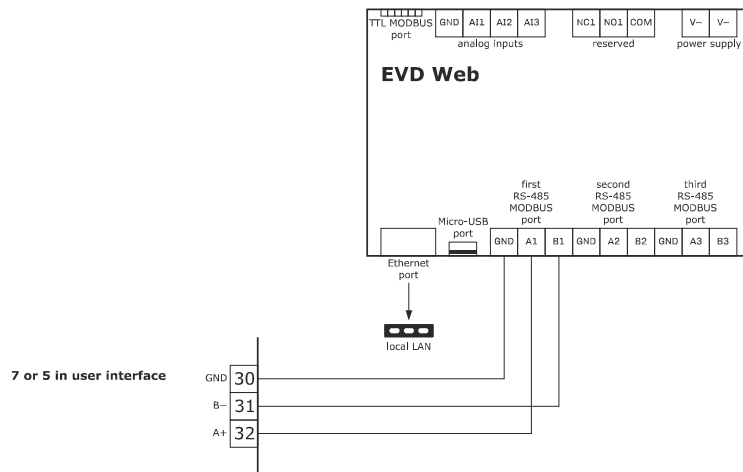

## 11.2 EPoCA cloud platform

EPoCA® is a remote management and monitoring system based on a cloud platform. Originally developed to meet the management needs of the food preservation and cooking sector, it has been expanded to HVAC units in response to market demand.

To connect to the cloud system and remotely control machinery from a PC, tablet or smartphone, all users need is an EVCO controller with native EPoCA® technology and connectivity which is either built-in or provided by external hardware modules. All devices are configured using the dedicated "EPoCA Start" mobile app.

The responsive design and the graphic interface conceived to provide a pleasant user experience make EPoCA® a "ready-to-use" solution for easily accessible management and monitoring operations, even for entry-level users, while offering all the typical functions of professional platforms.

With the appropriate protection measures for access and data, the system makes it possible for one or more enabled users to operate remotely on the unit to configure its parameters, activate cycles, receive automatic alerts, view data (also as a graph) and download records in the most popular formats, such as XLSX, CSV and PDF.

## 12 USB PORT MANAGEMENT

### 12.1 Available functions

The USB port provides the following functions:

- download to a USB flash drive the data relating to the cycles performed (HACCP history)
- download to a USB flash drive the recipes saved in the controller
- download to a USB flash drive the parameters saved in the controller
- upload to the controller the recipes in the USB flash drive
- upload to the controller the parameters in the USB flash drive
- upload to the controller CSV files to personalise the graphics, recipes and languages

Before inserting the flash drive in the on-board USB port, go to the STAND-BY screen (controller is powered but regulation is not activated) then insert the USB flash drive and the menu below will appear:

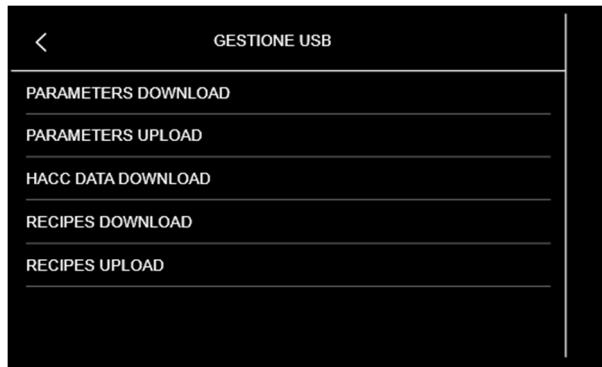

To download historical data, select the date from which to begin downloading HACCP data.

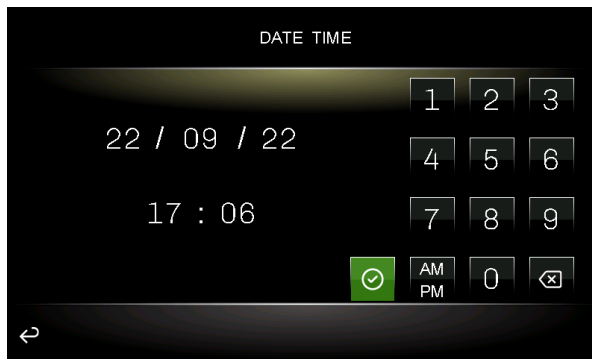

For the procedure to compile the ODS file, convert it to CSV, transfer to a USB flash drive and upload it to the controller, please refer to "Personalisation of the Vcolor platform".

### 13 ALARMS

When an alarm occurs, a red bar will appear at the top of the screen of the cycle in progress, and the buzzer, if enabled, will begin to sound; if several alarms are in progress at the same time, they will alternate on the bar every 3 seconds.

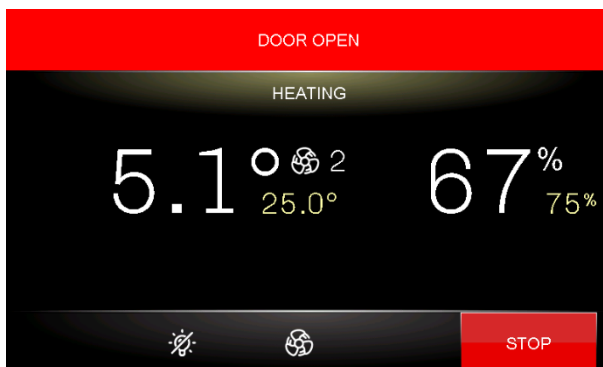

When the alarm bar is pressed, the buzzer will be silenced and the controller will automatically go to the ALARM LIST screen, where only the active alarms will be displayed:

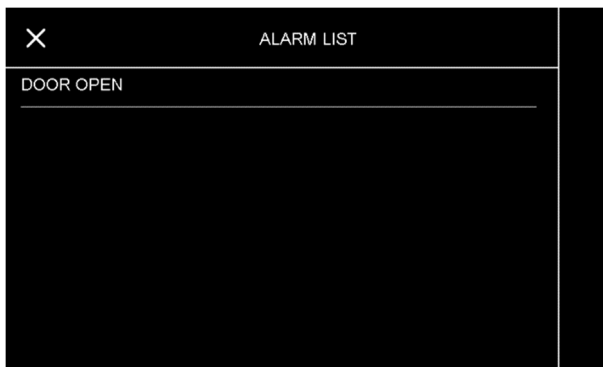

#### 13.1 Active alarms

To see the list of active alarms, press the MENU key and then ALARMS.

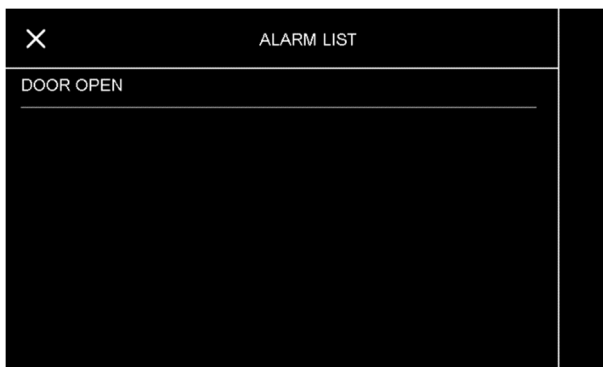

#### 13.2 ELSTEAM Mistral or Zephyr humidifier alarms

If the controller is connected to a Mistral or Zephyr humidifier, the message "Generic Humidifier Alarm" will appear on the controller display when a humidifier alarm occurs.

Press the relative line on the ALARM LIST screen and the page showing the current active humidifier alarms will open.

### 13.3 List of proofing/retarding-proofing alarms

Below is a list of the possible alarms, their effects on regulation and the action to take to correct them. The alarms highlighted in grey do not occur when proofing is configured (E12 = 0).

Alarm	Meaning
<b>HIGH EVAPORATOR TEMPERATURE</b>	<p>To correct:</p> <ul style="list-style-type: none"> <li>- check the evaporator temperature</li> <li>- check the value of parameters A1 and A2</li> </ul> <p>Main results:</p> <ul style="list-style-type: none"> <li>- all loads are deactivated</li> </ul>
<b>HIGH CABINET TEMPERATURE</b>	<p>To correct:</p> <ul style="list-style-type: none"> <li>- check the cabinet temperature</li> <li>- check the value of parameters A3 and A4</li> </ul> <p>Main results:</p> <ul style="list-style-type: none"> <li>- all the loads are deactivated until the alarm stops</li> <li>- the word alarm will disappear only when that area is pressed</li> </ul>
<b>DOOR OPEN</b>	<p>To correct:</p> <ul style="list-style-type: none"> <li>- check the condition of the door</li> <li>- check the value of parameters i0, i1 and i2</li> </ul> <p>Main results:</p> <ul style="list-style-type: none"> <li>- the effect set by parameter i0</li> </ul>
<b>HIGH PRESSURE</b>	<p>To correct:</p> <ul style="list-style-type: none"> <li>- check the state of the high pressure input</li> <li>- check the value of the parameters relating to the multi-purpose input configured as high pressure</li> </ul> <p>Main results:</p> <ul style="list-style-type: none"> <li>- the compressor and evaporator fan are switched off, the condenser fan remains on</li> </ul>
<b>LOW PRESSURE</b>	<p>To correct:</p> <ul style="list-style-type: none"> <li>- check the state of the low pressure input</li> <li>- check the value of the parameters relating to the multi-purpose input configured as low pressure</li> </ul> <p>Main results:</p> <ul style="list-style-type: none"> <li>- the compressor and condenser fan are switched off</li> </ul>
<b>COMPRESSOR THERMAL SWITCH</b>	<p>To correct:</p> <ul style="list-style-type: none"> <li>- check the state of the compressor thermal switch input</li> <li>- check the value of the parameters relating to the multi-purpose input configured as compressor thermal switch</li> </ul> <p>Main results:</p> <ul style="list-style-type: none"> <li>- the compressor is switched off</li> </ul>
<b>COMPRESSOR MAINTENANCE</b>	<p>To correct:</p> <ul style="list-style-type: none"> <li>- reset the counter of the compressor operation days</li> </ul> <p>Main results:</p> <ul style="list-style-type: none"> <li>- none; this is only a visual alarm and has no effect on regulation</li> </ul>
<b>THERMAL SWITCH</b>	<p>To correct:</p> <ul style="list-style-type: none"> <li>- check the state of the thermal switch input</li> <li>- check the value of the parameters relating to the multi-purpose input configured as thermal switch</li> </ul> <p>Main results:</p> <ul style="list-style-type: none"> <li>- all loads are deactivated</li> </ul>

<b>EVAPORATOR FAN THERMAL SWITCH ALARM</b>	<p>To correct:</p> <ul style="list-style-type: none"> <li>- check the condition of the multi-purpose input configured as the evaporator fan thermal switch alarm</li> </ul> <p>Main results:</p> <ul style="list-style-type: none"> <li>- the evaporator fan, humidifier, steriliser/oxygenator and heaters will be switched off</li> </ul>
<b>POWER FAILURE</b>	<p>To correct:</p> <ul style="list-style-type: none"> <li>- check the device-power supply connection</li> </ul>
<b>CONDENSER PRE-ALARM</b>	<p>To correct:</p> <ul style="list-style-type: none"> <li>- check the condenser temperature</li> <li>- check the value of parameter C6</li> </ul> <p>Main results:</p> <ul style="list-style-type: none"> <li>- the condenser fan will be switched on</li> </ul>
<b>CONDENSER OVERHEAT ALARM</b>	<p>To correct:</p> <ul style="list-style-type: none"> <li>- check the condenser temperature</li> <li>- check the value of parameters C7 and C8</li> <li>- disconnect the device from the power supply and clean the condenser</li> </ul> <p>Main results:</p> <ul style="list-style-type: none"> <li>- if the error occurs during an operating cycle, the cycle will be interrupted</li> </ul>
<b>PUMP-DOWN</b>	<p>To correct:</p> <ul style="list-style-type: none"> <li>- check the maximum pump-down time set by parameter u2</li> <li>- the alarm will be re-armed when the compressor is next activated or by pressing the buzzer silencing key</li> </ul> <p>Main results:</p> <ul style="list-style-type: none"> <li>- the compressor will be switched off</li> </ul>
<b>CABINET PROBE</b>	<p>To correct:</p> <ul style="list-style-type: none"> <li>- check the value of parameter P0</li> <li>- check the integrity of the probe</li> <li>- check the device-probe connection</li> <li>- check the cabinet temperature</li> </ul> <p>Main results:</p> <ul style="list-style-type: none"> <li>- if the error occurs during "stand-by", it will not be possible to start up an operating cycle</li> <li>- if the error happens during a cycle, the cycle will be interrupted</li> </ul>
<b>EVAPORATOR PROBE</b>	<p>To correct:</p> <ul style="list-style-type: none"> <li>- the same as for the cabinet probe error but with reference to the evaporator probe</li> </ul> <p>Main results:</p> <ul style="list-style-type: none"> <li>- if parameter P3 is set to 1, defrost will last for the time set by parameter d3</li> </ul>
<b>CONDENSER PROBE</b>	<p>To correct:</p> <ul style="list-style-type: none"> <li>- the same as for the cabinet probe error but with reference to the condenser probe</li> </ul> <p>Main results:</p> <ul style="list-style-type: none"> <li>- the condenser fan will operate in parallel with the compressor</li> <li>- the condenser overheat alarm will never be activated</li> <li>- the compressor locked alarm will never be activated</li> </ul>

<p><b>HUMIDITY PROBE</b></p>	<p>To correct:</p> <ul style="list-style-type: none"> <li>- check transducer integrity</li> <li>- check the device-transducer connection</li> <li>- check cabinet relative humidity</li> </ul> <p>Main consequences if parameter rU0 is set to 0:</p> <ul style="list-style-type: none"> <li>- if the error occurs during "stand-by", it will not be possible to start up humidity management cycles</li> <li>- if the error occurs during a humidity control cycle, the cycle will be interrupted</li> </ul>
<p><b>GENERIC ALARM</b></p>	<p>To correct:</p> <ul style="list-style-type: none"> <li>- check the condition of the multi-purpose input configured as the generic alarm</li> </ul> <p>Main results:</p> <ul style="list-style-type: none"> <li>- none; this is only a visual alarm and has no effect on regulation</li> </ul>
<p><b>RTC</b></p>	<p>To correct:</p> <ul style="list-style-type: none"> <li>- re-set the date and time</li> </ul> <p>Main results:</p> <ul style="list-style-type: none"> <li>- the device is unable to start up automatic cycles</li> <li>- any automatic cycles in progress will be blocked</li> </ul>
<p><b>NO BOARD COMMUNICATION</b></p>	<p>To correct:</p> <ul style="list-style-type: none"> <li>- check the user interface-control module connection</li> </ul> <p>Main results:</p> <ul style="list-style-type: none"> <li>- cycle in progress interrupted</li> </ul>
<p><b>WATER LOADING</b></p>	<p>To correct:</p> <ul style="list-style-type: none"> <li>- check the connection with the Wter loading system</li> <li>- manually reset the alm from the page ALARM LIST</li> </ul> <p>Main results:</p> <ul style="list-style-type: none"> <li>- the water loading will be interrupted</li> </ul>
<p><b>EXPANSION COMMUNICATION</b></p>	<p>To correct:</p> <ul style="list-style-type: none"> <li>- check the connection between the expansion and the control module</li> </ul> <p>Main results:</p> <ul style="list-style-type: none"> <li>- cycle in progress interrupted</li> </ul>

### 13.4 List of EVCO inverter alarms

Below is a list of the alarms that may be displayed when the controller is connected to an EVCO inverter. For their effects on regulation and the action to take to correct them, consult the dedicated section in the manual of the inverter used, which can be downloaded from the site: <https://www.evco.it/en/16463-inverter>.

INVERTER COMMUNICATION  
 INVERTER SYNCHRONISATION  
 INVERTER UNDERVOLTAGE  
 INVERTER OVERVOLTAGE  
 INVERTER OVERLOAD  
 INVERTER OVERCURRENT  
 INVERTER HEAT SINK OVERHEAT

### 13.5 List of ELSTEAM Mistral or Zephyr humidifier alarms

The controller displays humidifier alarms only when it is connected to an ELSTEAM humidifier from the Mistral or Zephyr series via the RS-485 serial port. If a generic humidifier is used, no alarm is displayed by the controller.

<b>HUMIDIFIER COMMUNICATION</b>	<p>This occurs if there is no communication between Vcolor and the Mistral or Zephyr humidifier</p> <p>To correct:</p> <ul style="list-style-type: none"> <li>- check the connections between Vcolor and the Mistral humidifier</li> </ul>
<b>GENERIC HUMIDIFIER ALARM</b>	<p>This occurs when the Mistral or Zephyr humidifier is not functioning properly</p> <p>To correct:</p> <ul style="list-style-type: none"> <li>check what kind of humidifier alarm is currently active by accessing the ALARM LIST screen (see section 13.2) and refer to what indicated for that specific alarm in the humidifier manual</li> </ul>

#### 13.5.1 List of Mistral alarms

Below is a list of the specific pre-alarms and alarms that may be displayed when the controller is connected to an ELSTEAM Mistral humidifier. For their effects on regulation and the action to take to correct them, consult the dedicated section in the manual of the humidifier used, which can be downloaded at the following link: <https://www.elsteam.it/en/download-2/>

##### Pre-alarms

MINIMUM CURRENT LOAD VALVE PRE-AL  
 MAXIMUM CURRENT LOAD VALVE PRE-AL  
 MINIMUM CURRENT DISCHARGE VALVE PRE-AL  
 MAXIMUM CURRENT DISCHARGE VALVE PRE-AL  
 MINIMUM CURRENT MIST MAKER PRE-AL  
 MAXIMUM CURRENT MIST MAKER PRE-AL  
 MINIMUM CURRENT FAN PRE-AL  
 MAXIMUM CURRENT FAN PRE-AL

##### Alarms

MIST MAKER HOURS OF OPERATION  
 FAN HOURS OF OPERATION  
 LOW HUMIDITY  
 HIGH HUMIDITY  
 HIGH WATER LEVEL BOARD TEMP/TEMP PROBE FAULT  
 WATER LEVEL BOARD PROBLEM/SELF TEST  
 MINIMUM CURRENT LOAD VALVE  
 MAXIMUM CURRENT LOAD VALVE  
 MINIMUM CURRENT DISCHARGE VALVE  
 MAXIMUM CURRENT DISCHARGE VALVE

MINIMUM CURRENT MIST MAKER  
MAXIMUM CURRENT MIST MAKER  
MINIMUM CURRENT FAN  
MAXIMUM CURRENT FAN

### 13.5.2 List of Zephyr alarms

Below is a list of the specific pre-alarms and alarms that may be displayed when the controller is connected to an ELSTEAM Zephyr humidifier. For their effects on regulation and the action to take to correct them, consult the dedicated section in the manual of the humidifier used, which can be downloaded at the following link: <https://www.elsteam.it/en/download-2/>

#### Pre-alarms

+30% OVERCURRENT  
NO PRODUCTION  
INSUFFICIENT DRAINING  
FOAM  
SUSPECTED HIGH ELECTRICAL CONDUCTIVITY  
BOILER MAINTENANCE  
+30% OVERCURRENT BOILER 2  
NO BOILER 2 PRODUCTION  
INSUFFICIENT DRAINING BOILER 2  
BOILER 2 FOAM  
SUSPECTED HIGH ELECTRICAL CONDUCTIVITY BOILER 2  
BOILER 2 MAINTENANCE

#### Alarms

+50% OVERCURRENT  
NO PRODUCTION  
NO WATER  
MACHINE SERVICE LIFE  
BOILER SERVICE LIFE  
SOLENOID VALVE MAINTENANCE  
PUMP MAINTENANCE  
FAN MAINTENANCE  
CURRENT SENSOR  
+50% OVERCURRENT BOILER 2  
NO BOILER 2 PRODUCTION  
NO BOILER 2 WATER  
BOILER 2 SERVICE LIFE  
BOILER 2 SOLENOID VALVE MAINTENANCE  
BOILER 2 PUMP MAINTENANCE  
BOILER 2 FAN MAINTENANCE  
BOILER 2 CURRENT SENSOR  
EXPANSION BOARD BOILER 2



## 14 PARAMETERS

The table below describes the configuration parameters of the device when it is set to manage retarding-proofing (E12 = 1). To control proofing (E12 = 0), always refer to the table below, except for the parameters highlighted in grey which have no meaning in this configuration; with E12=0, remember to assign the correct values (namely those in grey in the "Default" column) to parameters Pr2, i3, i4, i7, i10, u3, u1c, u5c, u8c, u9c and u13c.

**N.B.:** once configuration of the parameters is complete, the device will automatically start up again.

Par.	Min	Max	M.U.	Default	Analogue inputs
CA1	-25.0	25.0	°C	0.0	probe 1 offset
CA2	-25.0	25.0	°C	0.0	probe 2 offset
CA3	-25.0	25.0	°C	0.0	probe 3 offset
CA4	-25	25	% r.H.	0	humidity probe offset (probe set by parameter P12)
P0	0	1	-----	1	type of temperature probe 0 = PTC 1 = NTC
P1	0	1	-----	1	decimal point when displaying temperature and setting the setpoint: 0 = disabled 1 = enabled
P2	0	1	-----	0	temperature measurement unit 0 = °C 1 = °F
P3	-1	240	min	10	duration of power failure during a cycle due to start of recording of power failure alarm P3 = -1 alarm disabled
P5	0	60	min	15	duration of power failure above which the cycle is interrupted <b>N.B.:</b> P5 must be greater than P3 if P3 = -1, the cycle is not interrupted, irrespective of the value of P5
P7	0	P8	% r.H.	0	lower calibration limit of the humidity transducer (corresponding to 4 mA) only if P12=1
P8	P7	100	% r.H.	100	upper calibration limit of the humidity transducer (corresponding to 20 mA) only if P12=1
P12	0	3	-----	1	type of humidity probe 0 = no probe 1 = 4-20 mA transducer 2 = EVHTP500 probe (NTC temperature sensor) 3 = EVHTP520 probe (NTC temperature sensor)
P13	0	1	-----	0	temperature and humidity setpoint lock 0 = no 1 = yes
Pr1	0	3	-----	1	probe 1 configuration 0 = disabled 1 = cabinet 2 = evaporator 3 = condenser
Pr2	0	3	-----	2 0	Probe 2 configuration See Pr1
Pr3	0	3	-----	0	Probe 3 configuration See Pr1
Par.	Min	Max	M.U.	Default	Cooling regulator

rC0	1.0	15.0	°C	2.0	parameter rC3, rC4, rC5 differential
rC1	-99.0	rC2	°C	-20.0	minimum setpoint that can be set for the blocking, holding, manual cooling and pre-cooling phases
rC2	rC1	99.0	°C	20.0	maximum setpoint that can be set for the blocking, holding, manual cooling and pre-cooling phases
rC3	0.0	10.0	°C	1.0	value of cooling neutral zone for the blocking, holding and manual cooling phases
rC4	0.0	10.0	°C	1.0	value of cooling neutral zone for the re-awakening, proofing and manual heating phases
rC5	0.0	10.0	°C	1.0	value of cooling neutral zone for the baking delay phase
rC6	-99.0	99.0	°C	2.0	pre-cooling setpoint
rC7 <sup>(1)</sup>	1	3	- - - -	1	number of regulation steps for the holding phase
rC8 <sup>(1)</sup>	1	100	%	20	percentage increase for the 1st holding step (out of a total of 100%)
rC9 <sup>(1)</sup>	1	100	%	50	percentage increase for the 2nd holding step (out of a total of 100%)
rC10 <sup>(1)</sup>	1	100	%	100	percentage increase for the 3rd holding step (out of a total of 100%)
<b>Par.</b>	<b>Min</b>	<b>Max</b>	<b>M.U.</b>	<b>Default</b>	<b>Heating regulator</b>
rH0	1.0	15.0	°C	2.0	parameter rH3, rH4, rH5 differential
rH1	-99.0	rH2	°C	0.0	minimum possible setpoint for the re-awakening, proofing, baking delay and manual heating phases
rH2	rH1	99.0	°C	40.0	maximum possible setpoint for the re-awakening, proofing, baking delay and manual heating phases
rH3	0.0	10.0	°C	1.0	value of heating neutral zone for the blocking, holding and manual cooling phases
rH4	0.0	10.0	°C	1.0	value of heating neutral zone for the re-awakening, proofing and manual heating phases
rH5	0.0	10.0	°C	1.0	value of heating neutral zone for the baking delay phase
rH6	1	600	s	60	cycle time for heater switch-on if heating is required (see also rH7)
rH7	1	600	s	45	heater switch-on time within the rH6 cycle time
rr0 <sup>(1)</sup>	1	10	- - - -	4	number of regulation steps for the re-awakening phase
rr1 <sup>(1)</sup>	1	100	%	25	percentage increase for the 1st re-awakening step (out of a total of 100%)
rr2 <sup>(1)</sup>	1	100	%	50	percentage increase for the 2nd re-awakening step (out of a total of 100%)
rr3 <sup>(1)</sup>	1	100	%	75	percentage increase for the 3rd re-awakening step (out of a total of 100%)
rr4 <sup>(1)</sup>	1	100	%	100	percentage increase for the 4th re-awakening step (out of a total of 100%)
rr5 <sup>(1)</sup>	1	100	%	1	percentage increase for the 5th re-awakening step (out of a total of 100%)
rr6 <sup>(1)</sup>	1	100	%	1	percentage increase for the 6th re-awakening step (out of a total of 100%)
rr7 <sup>(1)</sup>	1	100	%	1	percentage increase for the 7th re-awakening step (out of a total of 100%)
rr8 <sup>(1)</sup>	1	100	%	1	percentage increase for the 8th re-awakening step (out of a total of 100%)

rr9 <sup>(1)</sup>	1	100	%	1	percentage increase for the 9th re-awakening step (out of a total of 100%)
rr10 <sup>(1)</sup>	1	100	%	1	percentage increase for the 10th re-awakening step (out of a total of 100%)
rL0 <sup>(1)</sup>	1	10	- - - -	4	number of steps for heater regulation for the proofing phase
rL1 <sup>(1)</sup>	1	100	%	25	percentage increase for the 1st proofing step (out of a total of 100%)
rL2 <sup>(1)</sup>	1	100	%	50	percentage increase for the 2nd proofing step (out of a total of 100%)
rL3 <sup>(1)</sup>	1	100	%	75	percentage increase for the 3rd proofing step (out of a total of 100%)
rL4 <sup>(1)</sup>	1	100	%	100	percentage increase for the 4th proofing step (out of a total of 100%)
rL5 <sup>(1)</sup>	1	100	%	1	percentage increase for the 5th proofing step (out of a total of 100%)
rL6 <sup>(1)</sup>	1	100	%	1	percentage increase for the 6th proofing step (out of a total of 100%)
rL7 <sup>(1)</sup>	1	100	%	1	percentage increase for the 7th proofing step (out of a total of 100%)
rL8 <sup>(1)</sup>	1	100	%	1	percentage increase for the 8th proofing step (out of a total of 100%)
rL9 <sup>(1)</sup>	1	100	%	1	percentage increase for the 9th proofing step (out of a total of 100%)
rL10 <sup>(1)</sup>	1	100	%	1	percentage increase for the 10th proofing step (out of a total of 100%)
<b>Par.</b>	<b>Min</b>	<b>Max</b>	<b>M.U.</b>	<b>Default</b>	<b>Humidity regulator</b>
rU0	0	1	- - - -	0	humidity management mode: 0 = with humidity probe/transducer (only if P12≠0) 1 = without humidity probe/transducer, time intervals based on the percentage set
rU1	-99.0	99.0	°C	0.0	minimum cabinet temperature for inhibiting humidification control
rU2	1	600	s	60	cycle time for humidifier switch-on (only for rU0 = 1, see also rU3)
rU3	1	600	s	30	humidifier switch-on within rU2 cycle time to generate 100% humidity in cabinet (only for rU0 = 1, see also rU2)
rU4	0	2	- - - -	0	enable humidification/dehumidification control during the blocking, holding and manual cooling phases 0 = humidification/dehumidification control is disabled but the value of the humidity probe is displayed (only if P12≠0, otherwise dashes are displayed) 1 = humidification/dehumidification control is enabled (the value of the probe is displayed only if P12≠0, otherwise the setpoint is displayed) 2 = humidification/dehumidification control is disabled, the value of the humidity probe is not displayed, only three dashes
rU5	1	100	% r.H.	5	dehumidification differential
rU6	0	100	% r.H.	2	dehumidification neutral zone value
rU7	0	255	s	10	duration of dehumidification attempt with pump-down solenoid valve
rU8	1	100	% r.H.	5	humidification differential
rU9	0	100	% r.H.	2	humidification neutral zone value

rU10	0	50	% r.H.	10	humidification proportional band value (only for E3=0 and E6=0)
rU11	0	255	s	30	cycle time for humidification proportional regulation (only for E3=0 and E6=0)
rU12	0	1	-----	0	time base for humidification proportional regulation cycle time (only for E3=0 and E6=0): 0 = seconds 1 = minutes
rU13	0	100	%	80	maximum humidity setpoint that can be set
rU14	-99.0	99.0	°C	0.0	minimum cabinet temperature for inhibiting dehumidification control
rU15	0	300	s	60	humidifier pause time (only if E3=0 and E6=1)
rU16	0	60	s	3	humidifier activation time (only if E3=0 and E6=1)
rU17	0	1	-----	0	Enable heaters during dehumidification
<b>Par.</b>	<b>Min</b>	<b>Max</b>	<b>M.U.</b>	<b>Default</b>	<b>Compressor protection</b>
C0	0	240	min	0	compressor switch-on delay from device switch-on
C1	0	240	min	2	delay between two compressor switch-ons
C2	0	240	min	0	minimum compressor-off duration
C3	0	240	s	0	minimum compressor-on duration
C4	0	240	min	0	forced compressor-on time at the beginning of the re-awakening, proofing and baking delay phases
C6	0.0	164.0	°C	70.0	condensation temperature above which the condenser pre-alarm overheat message is displayed
C7	0.0	164.0	°C	80.0	condensation temperature above which the condenser overheat alarm is triggered
C8	0	15	min	1	compressor locked alarm delay
C9	0	99	hours	5	cabinet temperature consecutive time within proportional band (parameter VC1 for VSC compressors) to operate compressor at max. power C9=0 disabled
C10	0	999	days	0	operating time of compressor due to maintenance warning C10=0 function disabled
<b>Par.</b>	<b>Min</b>	<b>Max</b>	<b>M.U.</b>	<b>Default</b>	<b>Variable speed compressor protection</b>
VC1	0.0	99.0	°C	10.0	proportional band (relative to setpoint)
VC2	0	99	min	10	integral action time
VC3	1	7	-----	3	type of compressor 1 = Embraco VEM – VES 2 = Embraco VEG 3 = Embraco VNEK – VNEU – FMFT 4 = Secop VNL 50...150 Hz (40Hz in OFF) 5 = Secop 33...133 Hz 6 = Tecumseh 85...150 Hz 7 = Tecumseh 68...150 Hz
VC4	0	100	sec x 10	0	85 Hz compressor time from power-on
VC5	0	100	%	0	% to increase minimum compressor frequency. If VC5=0, the minimum operating frequency is that set by the compressor manufacturer
VC6	0	100	%	100	% to decrease maximum compressor frequency. If VC6=100, the maximum operating frequency is that set by the compressor manufacturer

Par.	Min	Max	M.U.	Default	Defrost
d0	0	99	h	6	automatic defrost interval 0 = defrost at intervals is never activated
d1	0	2	-----	0	type of defrost 0 = electrical (during defrosting the compressor is switched off, the defrost output is activated and the evaporator fan checks parameter F26) 1 = hot gas (during defrosting the compressor is switched on, the defrost output is activated and the evaporator fan checks parameter F26) 2 = air (during defrosting the compressor is switched off and the evaporator fan checks parameter F26); in this case, the defrost output is not used, even if it is configured
	-99.0	99.0	°C	8.0	defrost end threshold (evaporator temperature); see also parameter d3
d3	0	99	min	30	if parameter P3 is set to 0, defrost duration if parameter P3 is set to 1, maximum defrost duration; see also parameter d2 0 = defrost is never activated
d5	0	99	min	30	defrost delay from the start-up of holding/manual cooling (also for type "b" defrost) 0 = defrost will be activated once the time set by parameter d0 has elapsed
d7	0	15	min	2	drip time (during dripping the compressor and evaporator fan will remain off and the defrost output will be deactivated)
d15	0	99	min	0	minimum consecutive compressor-on duration for starting hot gas defrost when defrost interval elapses, only if parameter d1 is set to 1 (also for type "b" defrost)
d00	0	1	-----	0	enable type "b" defrost parameters on setpoint threshold 0 = no 1 = yes
d01	-99.0	99.0	°C	1.0	setpoint threshold to activate type "b" parameters (activated if setpoint>d01)
d0b	0	99	hours	6	automatic defrost interval for type "b" same meaning as parameter d0
d1b	0	2	-----	2	type of type "b" defrost same meaning as parameter d1
d2b	-99.0	99.0	°C	4.0	threshold of type "b" defrost; see also parameter d3b same meaning as parameter d2
d3b	0	99	min	20	type "b" defrost duration same meaning as parameter d3
d7b	0	15	min	0	type "b" dripping time same meaning as parameter d7
Par.	Min	Max	M.U.	Default	Temperature alarms
A1	0.0	99.0	°C	70.0	evaporator temperature above which the evaporator high temperature alarm is activated; see also parameter A2
A2	-1	240	min	1	delay evaporator high temperature alarm 1 = yes -1 = alarm not enabled
A3	0.0	99.0	°C	70.0	cabinet temperature above which the cabinet high temperature alarm is activated; see also parameter A4
A4	-1	240	min	1	delay high cabinet temperature alarm 1 = yes -1 = alarm not enabled

A16	0	900	sec	300	buzzer reactivation time if alarm(s) still active 0 = not enabled
A17	0	1	-----	0	alarm output activation 0 = with alarm active 1 = with alarm not active
<b>Par.</b>	<b>Min</b>	<b>Max</b>	<b>M.U.</b>	<b>Default</b>	<b>Evaporator and condenser fan</b>
F0	0	1	-----	0	evaporator fan activity during the blocking phase 0 = parallel function with the compressor 1 = continuous function
F1	0	1	-----	0	evaporator fan activity during the holding, cooling and pre-cooling phases 0 = parallel function with the compressor 1 = continuous function
F2	0	1	-----	0	evaporator fan activity during the re-awakening phase 0 = parallel function with the main loads 1 = continuous function
F3	0	1	-----	0	evaporator fan activity during the proofing phase 0 = parallel function with the main loads 1 = continuous function
F4	0	1	-----	0	evaporator fan activity during the baking delay phase 0 = parallel function with the main loads 1 = continuous function
F5	0	1	-----	0	evaporator fan activity during the heating phase 0 = parallel function with the main loads 1 = continuous function
F10	1	10	-----	10	fan speed during the dehumidification phase
F11	1	10	-----	10	fan speed during the pre-cooling phase
F12	0	15	min	2	fan stop after the dripping phase
F13	0	250	s	0	evaporator fan switch-off delay from main load switch-off
F14	1	600	s	0	evaporator fan cycle time if=0, cyclical fan switch-on will be deactivated
F15	1	600	s	0	evaporator fan switch-on time within the F14 cycle time
F16	0.0	99.0	°C	20.0	condenser fan threshold (if condenser probe is configured)
F17	0	240	s	5	condenser fan switch-off delay from compressor switch-off (if condenser probe is disabled)
F18	0	3	-----	2	condenser fan activation mode (if condenser probe is configured) 0 = temperature adjusted (with compressor ON or OFF) 1 = temperature adjusted only if compressor is OFF (on if compressor is ON) 2 = temperature adjusted only if compressor is ON (OFF if compressor is OFF) 3 = temperature adjusted if compressor is OFF, OFF during defrost
F19	0	240	s	15	evaporator fan switch-on delay from when the door is closed, or the door switch input is deactivated
F21	1	10	-----	8	evaporator fan start-up speed
F22	1	240	s	5	start-up time when the evaporator fan is switched on
F23	0	100	%	35	evaporator fan min. speed calibration value
F24	0	100	%	65	evaporator fan max. speed calibration value
F25	-50.0	99.0	°C	1.0	evaporator temperature below which the evaporator fan is

					activated for the blocking, holding and manual cooling phases
F26	0	1	- - - -	0	evaporator fan mode during defrost 0 = off 1 = on
F27	0	100	%	10	speed 1 evaporator fan, if E7=2 or 3
F28	0	100	%	20	speed 2 evaporator fan, if E7=2 or 3
F29	0	100	%	30	speed 3 evaporator fan, if E7=2 or 3
F30	0	100	%	40	speed 4 evaporator fan, if E7=2 or 3
F31	0	100	%	50	speed 5 evaporator fan, if E7=2 or 3
F32	0	100	%	60	speed 6 evaporator fan, if E7=2 or 3
F33	0	100	%	70	speed 7 evaporator fan, if E7=2 or 3
F34	0	100	%	80	speed 8 evaporator fan, if E7=2 or 3
F35	0	100	%	90	speed 9 evaporator fan, if E7=2 or 3
F36	0	100	%	100	speed 10 evaporator fan, if E7=2 or 3
<b>Par.</b>	<b>Min</b>	<b>Max</b>	<b>M.U.</b>	<b>Default</b>	<b>Setpoint of manual cooling and heating cycle</b>
MC1	-99.0	99.0	°C	-5.0	cabinet temperature setpoint in manual cooling
MC2	1	10	- - - -	10	fan speed in manual cooling
MC3	0	100	%	70	humidity setpoint in manual cooling
MC4	0	5999	min	120	duration manual cooling
MH1	-99.0	99.9	°C	25.0	cabinet temperature setpoint in manual heating
MH2	1	10	- - - -	10	fan speed in manual heating
MH3	0	100	%	80	humidity setpoint in manual heating
MH4	0	5999	min	180	duration manual heating
<b>Par.</b>	<b>Min</b>	<b>Max</b>	<b>M.U.</b>	<b>Default</b>	<b>Sanitation</b>
SA0	0	2	- - - -	0	type of sanitation 0 = not present 1 = UV lamp 2 = ozone generator
SA1	-99.0	99.0	°C	0.0	cabinet temperature below which the sanitation cycle, if started, is suspended
SA2	0	240	min	10	duration of sanitation cycle only if SA0=2 (see parameter E21 for resting time)
SA3	0	240	min	5	resting time after sanitation cycle if SA0=2 (if SA3=0, resting time is not taken into consideration)
<b>Par.</b>	<b>Min</b>	<b>Max</b>	<b>M.U.</b>	<b>Default</b>	<b>Digital inputs</b>
i0	0	6	- - - -	2	effect of the door opening, or when the door switch input is activated 0 = no effect 1 = the compressor and evaporator fan are switched off (no effect on light status) 2 = the evaporator fan is switched off (no effect on the compressor or light status) 3 = only light switched on 4 = the compressor and evaporator fan are switched off, the cabinet light is switched on 5 = the evaporator fan is switched off, the cabinet light is switched on 6 = the evaporator fan is switched off, the cabinet light (if on) is switched off; when the door is closed, the light goes back to its status before the door was opened  <b>N.B.:</b>

					<ul style="list-style-type: none"> <li>- if the door is opened, the humidifier, steriliser/oxygenator and heater are switched off</li> <li>- the light key has priority over the door switch; if the light has been switched on with the key, the door opening or closing will have no effect on light status</li> </ul>
i1	0	1	-----	0	door switch input contact type 0 = normally open (input active with contact closed) 1 = normally closed (input active with contact open)
i2	-1	120	min	5	door open alarm signal delay -1 = alarm not signalled
i3	-1	120	min	15	compressor and evaporator fan inhibition time from door open -1 = non considered
				-1	
i4	0	9	-----	1	Multi-purpose input 1 configuration: 0 = <u>DISABLED</u> 1 = <u>HIGH PRESSURE ALARM</u> (the compressor and evaporator fan are switched off, the condenser fan stays on) 2 = <u>LOW PRESSURE ALARM</u> (the compressor and evaporator fan are switched off; if the compressor is already being switched off, the alarm is not signalled and a reading bypass time given by i13 is activated). 3 = <u>PUMP-DOWN AND ALARM MANAGEMENT</u> (while the compressor is being switched off, the digital input will switch off the compressor output to end the pump-down phase; if the input is not activated within the time given by u2, the PUMP DOWN alarm is signalled. 4 = <u>COMPRESSOR THERMAL SWITCH ALARM</u> (the compressor is switched off) 5 = <u>GENERIC ALARM</u> (displayed only) 6 = <u>THERMAL SWITCH ALARM</u> (all loads are switched off) 7 = <u>DEVICE SWITCH ON/OFF</u> 8 = <u>EVAPORATOR FAN THERMAL SWITCH ALARM</u> (humidifier, steriliser/oxygenator, heaters are switched off) 9 = <u>WATER LOAD LEVEL</u> (activation water load output) 10 = <u>LOW PRESSURE AND PUMP DOWN ALARM</u> (During normal operation, the evaporator fans, the solenoid valve and the compressor are switched off and the LOW PRESSURE alarm is signalled; if the compressor is being switched off, the alarm is not signalled. If the input is not activated within the time given by u2, the PUMP DOWN alarm is signalled and a reading bypass time given by i13 is activated). 11 = <u>INSTANTANEOUS THERMAL SWITCH ALARM</u> (the compressor is switched off without delays).
				0	
i5	0	1	-----	0	multi-purpose input 1 contact type 0 = normally open (input active with contact closed) 1 = normally closed (input active with contact open)
i6	-1	240	s	5	multi-purpose input 1 alarm delay -1 = alarm not signalled
i7	0	9	-----	3	multi-purpose input 2 configuration see configurations of parameter i4
				0	
i8	0	1	-----	0	multi-purpose input 2 contact type 0 = normally open (input active with contact closed) 1 = normally closed (input active with contact open)
i9	-1	240	s	10	multi-purpose input 2 alarm delay -1 = alarm not signalled
i10	0	9	-----	2	multi-purpose input 3 configuration



				0	see configurations of parameter i4
i11	0	1	-----	0	multi-purpose input 3 contact type 0 = normally open (input active with contact closed) 1 = normally closed (input active with contact open)
i12	-1	240	s	5	multi-purpose input 3 alarm delay -1 = alarm not signalled
i13	0	240	s	40	reset time for the low pressure switch when the compressor is switched on (only if the digital input is configured = 2 or 10)
i14	0	240	sec x 10	30	time-out light off by door switch (no effect if lit by key). If i14=0, the light stays on until the door is closed
<b>Par.</b>	<b>Min</b>	<b>Max</b>	<b>M.U.</b>	<b>Default</b>	<b>Configurable digital outputs</b>
u1	0	1	-----	1	enable light key 0 = no 1 = yes <b>N.B.:</b> if u1=0 and a relay is configured as the light, it will be controlled by the door switch.
u2	0	240	s	90	- with multi-purpose digital input = 0 or 2: compressor deactivation delay from pump-down valve switch-off (pump-down being switched off) - with multi-purpose digital input =3: maximum pump-down duration in compressor switch-off mode without activating the low pressure input, causing the compressor to switch off and the pump-down alarm to sound (with u2=0 the alarm is not signalled)
u3	0	1	-----	1 0	dehumidification management type 0 = external dehumidifier/extractor fan (with this setting parameters rU5 and rU6 are relevant) 1 = by activating the refrigeration plant (not used if E12=0)
u4	0	1	-----	1	deactivation alarm output relay if buzzer silenced on keypad 0 = no 1 = yes
u5	-99.0	99.0	°C	-5.0	cabinet temperature under which the door frame heater is activated
u6	0	1	-----	1	enable alarm buzzer 0 = no 1 = yes
u7	0	999	s	60	water load timeout
u1c	0	18	-----	1	load associated with output K1 0 = not used 1 = compressor 2 = evaporator fan, max. speed (with both 1 or 2 speeds) 3 = condenser fan 4 = defrost 5 = cabinet light 6 = door frame heater 7 = alarm

				0	8 = pump-down 9 = on/stand-by 10 = evaporator fan, min. speed (only if with 2 speeds) 11 = sanitation 12 = heater 13 = humidity generator (boiler/mist maker) 14 = humidification/humidity injection 15 = dehumidification/extractor fan 16 = repeat buzzer events (alarms + machine status) 17 = water load 18 = dripping heater
u2c	0	18	-----	5	load associated with output K2 (see u1c)
u3c	0	18	-----	14	load associated with output K3 (see u1c)
u4c	0	18	-----	15	load associated with output K4 (see u1c)
u5c	0	18	-----	4	load associated with output K5 (see u1c)
				0	
u6c	0	18	-----	12	load associated with output K6 (see u1c)
u7c	0	18	-----	13	load associated with output K7 (see u1c)
u8c	0	18	-----	8	load associated with output K8 (see u1c)
				0	
u9c	0	18	-----	6	load associated with output K9 (see u1c)
				0	
u10c	0	18	-----	11	load associated with output K10 (see u1c), only with expansion
u11c	0	18	-----	9	load associated with output K11 (see u1c), only with expansion
u12c	0	18	-----	7	load associated with output K12 (see u1c), only with expansion
u13c	0	18	-----	3	load associated with output K13 (see u1c), only with expansion
				0	
Par.	Min	Max	M.U.	Default	Automatic testing
T1	-99.0	99.0	°C	35.0	cabinet temperature setpoint heating phase of testing cycle
T2	0	100	%	90	humidity setpoint heating phase of testing cycle
T3	0	999	min	60	maximum duration heating phase of testing cycle
T4	1	20	---	2	number of heater cycles (‘cycle’ means ON time + OFF time)
T5	-99.0	99.0	°C	-20.0	pulldown setpoint cooling phase
T6	-99.0	99.0	°C	-3.0	cabinet setpoint cooling phase of testing cycle
T7	0	999	min	60	maximum duration cooling phase of testing cycle
T8	1	20	-----	2	number of compressor cycles (‘cycle’ means ON time + OFF time)
T9	-99.0	99.0	°C	2.0	RECOVERY PHASE->CYCLE STOP setpoint
Par.	Min	Max	M.U.	Default	Serial communication (serial port type RS-485 with MODBUS communication protocol)
L1	1	240	min	15	internal data sampling time
LA	1	247	-----	247	device address
Lb	0	3	-----	3	baud rate (the parameter is relevant only if bLE = 0)

					0 = 2,400 baud 1 = 4,800 baud 2 = 9,600 baud 3 = 19,200 baud
LP	0	2	-----	2	parity 0 = none 1 = odd 2 = even
PA1	-99	999	-----	426	EPoCA level 1 password
PA2	-99	999	-----	824	EPoCA level 2 password
bLE	0	99	-----	0	serial port configuration for connectivity 0 = free for MODBUS RTU 1÷99 = EPoCA local network address (in this case the baud rate is automatically configured to 19,200 baud irrespective of the Lb value) <b>N.B.:</b> if connectivity comes from EVlinking Wi-Fi, the only value that can be set is 1
<b>Par.</b>	<b>Min</b>	<b>Max</b>	<b>M.U.</b>	<b>Default</b>	<b>Other</b>
E0	0	240	min	1	inactivity period for enabling screen-saver 0 = not enabled
E1	0	120	s	10	duration of buzzer at cycle end and on reaching pre-cooling setpoint
E2	0	240	min	0	duration of "cycle completed" display 0 = not enabled
E3	0	2	-----	0	humidifier type 0 = generic isothermal or adiabatic humidifier 1 = Mistral humidifier (set E6 and rU0=0, P12≠0) 2 = Zephyr humidifier (set E6 and rU0=0, P12≠0)
E4	0	2	-----	0	humidity generator relay management 0 = always ON 1 = ON only if the phase requires humidity and if the chamber probe < setpoint (of the phase in progress) 2 = ON only if the phase requires humidity 3 = ON only if the phase requires humidity and if the cabinet humidity value is < of the setpoint (of the phase in progress; with P12≠0)
E5	0	99	min	0	advance time of humidity generator relay switch-on compared to the humidity phase (if E4=1 or 2) 0 = no pre-switch-on
E6	0	1	-----	0	type of humidification regulation 0 = proportional (rU11, rU12) 1 = ON-OFF cycles (rU15, rU16)
E7	0	4	-----	0 <sup>(2)</sup>	type of evaporator fan regulation 0 = 1 speed (with relay configured as "2") 1 = 2 speeds (with relays configured as "2" and "10") 2 = 10 steps 0-10V output or EVCO inverter on 485 serial port 3 = 10 steps PWM output with EVDFAN 1 module or EVCO inverter on 485 serial port 4 = as configuration E7=1 but with 2 relays active at the same time for maximum speed
E8	0	2	-----	0	output configuration 0÷10V in Vcolor 689 models 0 = not used 1 = evaporator fan (E7=2) 2 = variable speed compressor (parameter VC3)

E9	0	1	----	0	enable user management/login 0 = disabled 1 = enabled
E10	0	1	----	0	enable additional modules 0 = none 1 = expansion module 2 = inverter 3 = expansion + inverter
E11	0	1	----	1	enable manual cycle time 0 = disabled 1 = enabled
E12	0	1	----	1 0	Machine configuration 0 = proofing 1 = retarding-proofing <b>N.B.:</b> changing this parameter from 0 to 1 deactivates any outputs that may be configured for the compressor; when changing from 1 to 0, check the configuration parameters for the outputs and the parameters for generating cooling
E13	10	100	%	10	display brightness
E14	1	300	s	60	display brightness timeout
E15	0	240	min	0	dripping heater deactivation delay from the end of defrost
E16	-99.0	99.9	°C	0	minimum cabinet temperature to enable water loading
<b>Par.</b>	<b>Min</b>	<b>Max</b>	<b>M.U.</b>	<b>Default</b>	<b>MISTRAL HUMIDIFIER <sup>7)</sup></b>
HS1	0	100	%	0	minimum humidity setpoint value (see r1 in Mistral manual)
HS2	0	100	%	95	maximum humidity setpoint value (see r2 in Mistral manual)
HS3	1	240	s	20	cycle time (see r3 in Mistral manual)
HS4	0	3	---	2	fan speed (see F0 in Mistral manual) 0 = fan off 1 = 30% 2 = 60% 3 = 80%
HS5	70	1250	µS*cm	500	water conductivity (see P1 in Mistral manual)
HS6	0	250	h	12	no production of RH consecutive time due to tank emptying for health and hygiene management (see c0 in Mistral manual) 0 = function disabled
HS7	0	250	h	24	production of RH consecutive time due to tank emptying for health and hygiene management (see c1 in Mistral manual) 0 = function disabled
<b>Par.</b>	<b>Min</b>	<b>Max</b>	<b>M.U.</b>	<b>Default</b>	<b>ZEPHYR HUMIDIFIER<sup>(8)</sup></b>
KHS1	0	100	%	20	minimum humidity setpoint value (see r5 in Zephyr manual)
KHS2	0	100	%	75	maximum humidity setpoint value (see r6 in Zephyr manual)
KHS5	0	1250	µS*cm	0	water conductivity (see P1 in Zephyr manual)
KHS6	0	10	days	2	no production of RH consecutive time due to tank emptying for health and hygiene management (see c0 in Zephyr manual) 0 = function disabled
KHS7	0	100	days	14	production of RH consecutive time due to tank emptying for health and hygiene management (see c1 in Zephyr manual) 0 = function disabled
<b>Par.</b>	<b>Min</b>	<b>Max</b>	<b>M.U.</b>	<b>Default</b>	<b>EVCO INVERTER<sup>(3)</sup></b>
S202	2	2000	ds (s/10)	30	duration acceleration ramp

S203	2	2000	ds (s/10)	50	duration deceleration ramp
S204	S205 <sup>(6)</sup>	3000	RPM	1500	maximum motor speed
S205	150	S204 <sup>(6)</sup>	RPM	300	minimum motor speed
S206	0	1	---	0	motor rotation direction 0 = clockwise 1 = anti-clockwise
S403	0	600	ds (s/10)	50	time-out inverter communication alarm 0 = disabled
S501 <sup>(4)</sup>	1	50 <sup>(5)</sup>	dA (A/10)	29 <sup>(5)</sup>	nominal current
S502 <sup>(4)</sup>	50	400	V	230	nominal voltage
S503 <sup>(4)</sup>	0	100	Hz	50	nominal frequency
S504 <sup>(4)</sup>	1	8	---	2	number of pole pairs
S506 <sup>(4)</sup>	1	3000	RPM	1390 (5)	nominal inverter revolutions
S508	1	100	---	81	nominal power factor
S509	0	25	%	5	overvoltage percentage applied at motor start-up (motor boost)
S511	0	100	%	50	motor overload
S512	0	60	s	30 (5)	maximum time motor overload
S529	5	16	kHz	5	PWM carrier frequency

**Notes:**

- (1) Notes for parameters rC7 - rC10 and rr0 - rL10:  
the controller does not carry out automatic adaptation of the percentages set. Check that the settings for the percentages and number of steps are consistent.
- (2) The value set for parameter E7 only applies to Vcolor 679 models with PWM output; make sure the parameter is set correctly in Vcolor 689 models with 0-10V output.
- (3) For a complete list of inverter parameters, see the dedicated documentation supplied with the inverter used. Except for S403, all parameters with their relative interval and default values are acquired when the inverter is switched on.
- (4) The parameter depends on the motor rating label data.
- (5) Values may differ depending on the inverter installed: the values indicated refer to the Compact inverter with power 0.75 KW and are given purely for reference purposes.
- (6) The upper limit of the minimum motor speed depends on the value set for S204; similarly, the lower limit of the maximum motor speed depends on the value set for S205: it is not possible, for instance, to set the minimum motor speed (parameter S205) at a value which is higher than the value of the maximum motor speed (parameter S204).
- (7) For a complete list of Mistral humidifier parameters, see the dedicated documentation supplied with the Mistral model used. Always switch the Mistral off and then on again after changing humidifier parameters.
- (8) For a complete list of Zephyr humidifier parameters, see the dedicated documentation supplied with the Zephyr model used. Always switch the Zephyr off and then on again after changing humidifier parameters.

## 15 ACCESSORIES

### 15.1 4 relay expansion

EVC20P52N9XXX10: 4 electro-mechanical relays

EVC20P52N9XXX12: 4 HC sealed relays



### 15.2 Phase cutting speed regulator

EVDFAN1

Makes it possible to regulate single-phase fan speed with a PWM command signal. The maximum operating current is 5 A.



### 15.3 EVCO Inverter

Enables modulating management of asynchronous motors.

Compact series: EI750M2C0400VXX/EI1K5M2C0400VXX/EI2K2M2C0400VXX/EI2K3M2C0400VXX

Single-phase inverter 0.75/1.5/2.2/2.3 KW @ 230 VAC.



Slim Power series: EI550M2L02TXVXX/ EI550M2L12TXVXX/ EI550M2L22TXVXX

Single-phase inverter with power up to 550 W @ 230 VAC.



Slim series: EI250M2S0200

Single-phase inverter with power up to 250 W @ 230 VAC.



## 15.4 Mistral humidifier

Ultrasonic humidifier with production capacity of up to 1 kg/h.



## 15.5 Zephyr humidifier

Immersed electrode humidifier with production capacity from 3 kg/h to 100 kg/h.



## 15.6 Safety transformer

ECTSFD004

The transformer can power the user interface.



## 15.7 Non-optoisolated RS-485/USB serial interface

EVIF20SUXI

The interface enables the device to be connected to the Parameters Manager set-up software system.



## 15.8 USB plug for panel installation

0812000002

The plug makes the USB communications port of the device more accessible.

To connect the device to the plug, connecting cable 0810500018 or 0810500020 must be used (to be ordered separately).



## 15.9 Connecting cables

0810500018/0810500020

These cables are used to connect the USB plug for panel installation 0812000002 to the device.

Cable 0810500018 is 2 m long; cable 0810500020 is 0.5 m long.



## 15.10 4GB USB flash drive

EVUSB4096M

The flash drive makes it possible to upload and download the settings and the data recorded by the device.



## 15.11 EVlinking Wi-Fi RS-485 module

EVIF25SWX

Through the RS-485 communications port, the module provides the controller with Wi-Fi connectivity which enables remote management and monitoring from the Internet using the EPoCA® cloud system.



## 15.12 EV3 Web IoT gateway

EV3W01

IoT gateway with Ethernet connectivity and data logging functions to remotely monitor and control an RS-485 MODBUS RTU network with up to 10 EVCO controllers with EPoCA® technology using the EPoCA® cloud platform.





### 15.13 EVD Web IoT gateway

EVDW01Z9

IoT gateway with Ethernet connectivity, data logging and date/time synchronization functions which allows users to remotely monitor and control up to 19 EVCO devices with EPoCA® technology using the EPoCA® cloud platform.



### 15.14 NTC temperature and humidity probe

EVHTP520

Temperature/humidity probe suitable for critical environments. Range: -10... 70 °C, 5... 95 % RH



### 15.15 Humidity transducer 4÷20 mA

EVHP523

High-precision humidity transducer. Range: 5... 95 % RH



## 16 TECHNICAL SPECIFICATIONS

### 16.1 Technical data

<b>Purpose of the control device:</b>	function controller		
<b>Construction of the control device:</b>	built-in electronic device		
<b>Housing:</b>	user interface	control module	
	black, self-extinguishing plastic	open frame board.	
<b>Category of heat and fire resistance:</b>	D		
<b>Measurements:</b>	user interface M (horizontal)	user interface L (horizontal)	control module
	Flush installation: 166.0 x 118.0 x 35.0 mm (6,535 x 4,645 x 1,377 in; L x H x D).	Flush installation: 216.0 x 156.0 x 50.0 mm (8,503 x 6,141 x 1,968 in; L x H x D)	166.0 x 116.0 x 44.0 mm (6,535 x 4,566 x 1,732 in; L x H x D)
	fit	fit	
	Semi-recessed installation: 145.1 x 97.1 x 32.0 mm (5,712 x 3,822 x 1,259 in; L x H x D).	Semi-recessed installation: 192.9 x 131.9 x 47.0 mm (7,594 x 5,192 x 1,850 in; L x H x D).	
<b>Mounting methods for the control device:</b>	user interface	control module	
	flush with the panel from behind with threaded studs (not provided) to hold it in place or semi-recessed from the front of the panel using the spring clips	on a flat surface with spacers	
<b>Degree of protection:</b>	user interface	control module	
	IP65 (front)	IP00.	
<b>Connection method:</b>	user interface	control module	
	plug-in screw terminal blocks for wires up to 1.5 mm <sup>2</sup> , type A female USB connector (USB port)	plug-in screw terminal blocks for wires up to 2.5 mm <sup>2</sup>	
	Maximum permitted length for connection cables:		
	<ul style="list-style-type: none"> <li>- user interface-control module connection: 10 m (32.8 ft)</li> <li>- power supply: 10 m (32.8 ft)</li> <li>- analogue inputs: 10 m (32.8 ft)</li> <li>- digital inputs: 10 m (32.8 ft)</li> <li>- analogue outputs: 10 m (32.8 ft)</li> <li>- digital outputs: 100 m (328 ft)</li> <li>- RS-485 MODBUS port: 1,000 m (3,280 ft)</li> <li>- USB port: 1 m (3.28 ft)</li> </ul>		
<b>Operating temperature:</b>	from 0 to 55 °C (from 32 to 131 °F)		
<b>Storage temperature:</b>	from -10 to 70 °C (from 14 to 158 °F)		
<b>Operating humidity:</b>	relative humidity without condensate from 10 to 90%		

<b>Pollution status of the control device:</b>	2.	
<b>Environmental standards:</b>	<ul style="list-style-type: none"> <li>- RoHS 2011/65/EC</li> <li>- WEEE 2012/19/EU</li> <li>- REACH (EC) Regulation no. 1907/2006</li> </ul>	
<b>EMC standards:</b>	<ul style="list-style-type: none"> <li>- EN 60730-1</li> <li>- IEC 60730-1.</li> </ul>	
<b>Power supply:</b>	user interface	control module
	Vcolor 679 M: powered by the control module Vcolor 679 L: 12 Vac 20 VA.	115... 230 VAC ( $\pm 15\%$ ), 50 / 60 Hz ( $\pm 3$ Hz), 10 VA max.
<b>Rated impulse withstand voltage:</b>	4 KV	
<b>Overvoltage category:</b>	III	
<b>Software class and structure:</b>	A	
<b>Clock:</b>	built-in (with secondary lithium battery)	
	Clock drift: $\leq 60$ s/month at 25 °C (77 °F)	
	Clock battery autonomy in the absence of a power supply: > 6 months at 25 °C (77 °F)	
	Clock battery charging time: 24 h (the battery is charged by the power supply of the device)	
<b>Analogue inputs:</b>	5 inputs of which 3 for PTC/NTC (terminals 25 - 29), 1 for 4-20mA (humidity probe, terminals 30 - 32), 1 for EVCO EVHTP520 humidity probe (terminals 23-24)	
	<i>PTC type analogue inputs</i>	
	Type of sensor:	KTY 81-121 (990 @ 25°C, 77°F).
	Measurement field:	from -50 to 150 °C (from -58 to 302 °F)
	Resolution:	0.1 °C (1 °F)
Protection:	none.	
<i>NTC type analogue inputs</i>		
Sensor type:	B3435 (10 K $\Omega$ @ 25°C, 77°F).	
Measurement field:	from -40 to 105 °C (from -40 to 221 °F).	
Resolution:	0.1 °C (1 °F)	
Protection:	none	
<i>4-20 mA type analogue inputs</i>		
Measurement field:	can be configured.	
Protection:	none.	
<i>analogue inputs for EVHTP520</i>		
Measurement field:	5-95 %rH	
Protection:	none	
<b>Digital inputs:</b>	4 voltage-free.	

	<p><i>Voltage-free</i></p> <p>Type of contact: 5 Vdc, 2 mA.</p> <p>Power supply: none</p>
<b>Modulating outputs:</b>	<p>Vcolor 679 models:</p> <p>1 for PWM signal (for phase cutting speed regulator for single-phase EVDFAN1 fans) (terminals 33-34).</p> <p>Vcolor 689 models:</p> <p>1 configurable for 0÷10Vdc signal to modulate evaporator fan speed or to control frequency on variable speed compressors (terminals 34-35)</p>
<b>Digital outputs:</b>	<p>9 outputs on the control module:</p> <ul style="list-style-type: none"> <li>- 1 16 A res. @ 250 VAC type SPST (K1) configurable output</li> <li>- 1 8 A res. @ 250 VAC type SPDT (K2) configurable output</li> <li>- 1 8 A res. @ 250 VAC type SPST (K3) configurable output</li> <li>- 1 8 A res. @ 250 VAC type SPST (K4) configurable output</li> <li>- 1 8 A res. @ 250 VAC type SPDT (K5) configurable output</li> <li>- 1 16 A res. @ 250 VAC type SPST (K6) configurable output</li> <li>- 1 16 A res. @ 250 VAC type SPST (K7) configurable output</li> <li>- 1 8 A res. @ 250 VAC type SPST (K8) configurable output</li> <li>- 1 8 A res. @ 250 VAC type SPST (K9) configurable output</li> </ul> <p>4 outputs on expansion (electro-mechanical relays)</p> <ul style="list-style-type: none"> <li>- 1 30 A res. @ 250 VAC type SPST (K10) configurable output</li> <li>- 1 16 A res. @ 250 VAC type SPST (K11) configurable output</li> <li>- 1 8 A res. @ 250 VAC type SPST (K12) configurable output</li> <li>- 1 16 A res. @ 250 VAC type SPDT (K13) configurable output</li> </ul> <p>* The relays do not control LED or fluorescent lights</p>
<b>Displays:</b>	<p>5 or 7-inch TFT touch-screen graphic display, 16K colours, 800 x 480 pixel resolution The presence of imperfection points on the display is within the tolerance limits as established by the reference standards</p>
<b>Type 1 or Type 2 actions:</b>	Type 1
<b>Additional features of Type 1 or Type 2 actions:</b>	C
<b>Communications ports:</b>	<p>2 ports:</p> <ul style="list-style-type: none"> <li>- 1 RS-485 MODBUS port</li> <li>- 1 USB port</li> </ul>
<b>Warning and alarm buzzer:</b>	built-in

**Vcolor 679/689**

Controller for retarding-proofing or proofing cabinets and rooms with customised graphic skin

Installer manual ver. 3.0

PB -24/24

Code 144VC679E304

This document and the solutions contained therein are the intellectual property of EVCO and thus protected by the Italian Intellectual Property Rights Code (CPI). EVCO forbids the reproduction and distribution, even in part, of the contents, unless express authorisation is obtained directly from EVCO. The customer (manufacturer, installer or end user) assumes all responsibility for the configuration of the device. EVCO accepts no liability for any possible errors in this document and reserves the right to make any changes at any time without prejudice to the essential functional and safety features of the equipment.



EVCO S.p.A.

Via Feltre 81, 32036 Sedico Belluno ITALY

Tel. +39 0437/8422 | Fax +39 0437/83648

info@evco.it | www.evco.it